

# 2019 PRODUCT DATA



**JNILOCK**<sup>®</sup>  
DESIGNED TO CONNECT.

# UNILOCK® QUALITY GUARANTEED



## GOOD CLASSIC

Our budget-friendly, Unilock Classic pavers and walls are manufactured to exceed ASTM standards for quality and strength. Available in classic shapes and styles, these products utilize a traditional **product mix of large and small aggregates**, that's consistent from top to bottom, with color mixed throughout.

## BETTER ENDURACOLOR™

The refined surface of Unilock Enduracolor products is achieved with a **two step manufacturing process** that combines a base of coarser aggregates for a **stronger foundation**, with concentrated color and **wear-resistant finer aggregates on top**. This process protects the surface from the appearance of fading over time because the top layer prevents large, lighter color aggregates from ever showing through.

## BEST ELEGANCE™

**Deep, rich colors** and a multitude of **unique Reala™ textures** combine to deliver the timeless beauty of Unilock Elegance. From the timeworn look of European cobblestones, to the classic luxury of riven natural stone slabs, our Elegance collection offers styles you can't get anywhere else and thanks to Ultima Concrete, the look you purchase is the look that will last, with up to **4x the strength** of poured in place concrete.



## EXCLUSIVE UNILOCK TECHNOLOGIES

### REALA™

Ultra realistic textures cast from Natural Stone, brick and historic cobblestones.

### ULTIMA™

A proprietary manufacturing process creates pavers with up to four times the strength of poured concrete.

### COLORFUSION™

A proprietary technology that disperses color randomly for a natural granite-like appearance.

### EASYCLEAN™

Factory sealed to provide integral surface protection from stains

There are two Clean Factors (CF®) to choose from:

CLEAN FACTORS (CF)	CF 90	CF 100
Pavers are pre-sealed at the factory	*	*
Enhanced resistance to weathering	*	*
Reduced dirt absorption	*	**
Stains from leaves, coffee, ketchup, mustard, wine and BBQ oils are easier to remove	*	**

# NEW FOR 2019

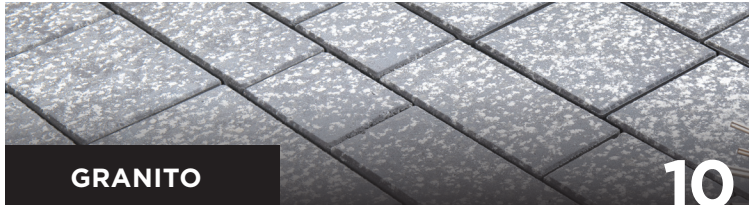

## PAGE PAVERS

2	Artline™	
3	Avante Ashlar™	
3	Beacon Hill™ Classic	<b>NEW</b>
4	Beacon Hill Flagstone™ & Smooth	<b>NEW</b>
5	Boulevard	
5	Bristol Valley®	
6	Brussels Block®	
6	Camelot™ & Tumbled Camelot™	
7	Cophorne®	
8	Courtstone®	
8	Eco-Optiloc™	
9	Eco-Line™	<b>NEW</b>
9	Eco-Priora™ Standard Finish	
10	Eco-Promenade®	<b>NEW</b>
10	Granito™	<b>NEW</b>
11	Holland Premier™	
11	Hollandstone™	
12	Il Campo®	
12	Mattoni	
13	Natural Stone	
15	Optiloc®	
14	Porcelain Tile	
15	Promenade® Plank Paver	<b>NEW</b>
16	Richcliff®	
16	Rivenstone™	
17	Senzo™	
17	Series™	
18	SkyLine™	<b>NEW</b>
18	Stonehenge®	
19	Thornbury™	
19	Town Hall®	
20	Treo™ Premier	
20	Tribeca Cobble	
22	Turfstone™	
21	Umbriano®	
22	Unigranite®	

## PAGE RETAINING WALLS

23	Brussels Dimensional System™
24	DuraHold®
25	DuraHold2®
26	Estate Wall®
27	Lineo™ Dimensional Stone
28	Pisa2®
29	Rivercrest® Wall
30	RomanPisa®
30	RomanStack®
31	SienaStone®
32	SplitN'Stack®
33	U-Cara™
35	Brussels Fullnose™ & Double Fullnose™
35	Ledgestone™ Pillar Caps, Coping & Fullnose
36	Ledgestone™ Steps
36	Universal Coping

## PAGE PRODUCT & INSTALLATION INFORMATION

37	Laying Patterns
39	Unilock Elements
41	Rivercrest® Fire Pit & Sunset Fire Pits
42	Sealers, Cleaners & Sands
48	Tools & Accessories
52	Charts & Calculations
54	Important Notes
55	Finishes & Color Blends
56	Product Directory



This symbol indicates that the product facilitates the flow of water from the surface into the joints and into the ground below.



BIRCH



PLATINUM



WALNUT

ANTIQUED FINISH **NEW FOR 2019**



BAVARIAN



STEEL MOUNTAIN

**TECHNICAL ADVANTAGE**

**EasyClean™ Stain Resistance - CF 90**

An integral surface protection that allows for easier cleanup of spills when they happen, and before a stain can develop.



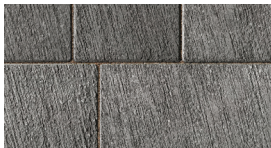

To create a one-of-a-kind custom look, Artline is also available in the finish below:

IL CAMPO® FINISH



PLATINUM BRUSHED FINISH

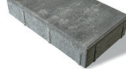
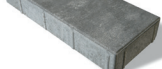

 6 3/8" x 4 7/8" x 2 3/4" (16.9cm x 12.5cm x 7cm)	 10 3/8" x 4 7/8" x 2 3/4" (26.25cm x 12.5cm x 7cm)	 13 3/8" x 4 7/8" x 2 3/4" (33.75cm x 12.5cm x 7cm)	 17 3/4" x 4 7/8" x 2 3/4" (45cm x 12.5cm x 7cm)
 8 7/8" x 7 1/2" x 2 3/4" (22.5cm x 18.75cm x 7cm)	 13 3/8" x 7 1/2" x 2 3/4" (33.75cm x 18.75cm x 7cm)	 17 3/4" x 7 1/2" x 2 3/4" (45cm x 18.75cm x 7cm)	

Individual units cannot be sold separately  
**Random Bundle**

Stones & Bundling	Unit Thickness	SqFt Per				Per Bundle		Soldier LnFt Per			Sailor LnFt per			Units Per			Lbs Per		
		Bundle	Layer	Section	Stone	Layers	Sections	SqFt	Section	Bundle	SqFt	Section	Bundle	SqFt	Section	Bundle	Layer	Section	Bundle
Random Bundle		93.25	11.66	-	-	8	-	-	-	-	-	-	-	-	-	192	364	-	2,911
Random Bundle - Antiqued		93.25	11.66	-	-	8	-	-	-	-	-	-	-	-	-	192	364	-	2,963
Unit A	2 3/4" (7cm)	-	-	-	-	-	-	-	-	-	-	-	-	-	-	32	-	-	-
Unit B	2 3/4" (7cm)	-	-	-	-	-	-	-	-	-	-	-	-	-	-	32	-	-	-
Unit C	2 3/4" (7cm)	-	-	-	-	-	-	-	-	-	-	-	-	-	-	32	-	-	-
Unit D	2 3/4" (7cm)	-	-	-	-	-	-	-	-	-	-	-	-	-	-	32	-	-	-
Unit E	2 3/4" (7cm)	-	-	-	-	-	-	-	-	-	-	-	-	-	-	32	-	-	-
Unit F	2 3/4" (7cm)	-	-	-	-	-	-	-	-	-	-	-	-	-	-	16	-	-	-
Unit G	2 3/4" (7cm)	-	-	-	-	-	-	-	-	-	-	-	-	-	-	16	-	-	-

Notes: Sold in full bundles only. Product is shipped on skids. All measurements are nominal. [Read the Polymeric Sand advisory on Page 46.](#)  
**Important:** Textured surfaces require a buffer between the plate compactor and the paver surface to prevent scuffing.

# AVANTE ASHLAR™

ENDURACOLOR™



RIVER



SIERRA



UNIT A 11 1/2" x 19" x 2 3/4" 29.1cm x 48.5cm x 7cm  
 UNIT B 11 1/2" x 19" x 2 3/4" 29.1cm x 48.5cm x 7cm  
 UNIT C 11 1/2" x 19" x 2 3/4" 29.1cm x 48.5cm x 7cm  
 UNIT D 11 1/2" x 19" x 2 3/4" 29.1cm x 48.5cm x 7cm

Random Bundle  
Individual units cannot be sold separately

Stones & Bundling	Unit Thickness	SqFt Per				Per Bundle		Soldier LnFt Per			Sailor LnFt per			Units Per			Lbs Per		
		Bundle	Layer	Section	Stone	Layers	Sections	SqFt	Section	Bundle	SqFt	Section	Bundle	SqFt	Section	Bundle	Layer	Section	Bundle
Random Bundle:		90.75	-	-	-	8	-	-	-	-	-	-	-	-	-	64	360	-	2,883
Unit A	2 3/4" (7cm)	-	-	-	-	-	-	-	-	-	-	-	-	-	-	24	-	-	-
Unit B	2 3/4" (7cm)	-	-	-	-	-	-	-	-	-	-	-	-	-	-	16	-	-	-
Unit C	2 3/4" (7cm)	-	-	-	-	-	-	-	-	-	-	-	-	-	-	8	-	-	-
Unit D	2 3/4" (7cm)	-	-	-	-	-	-	-	-	-	-	-	-	-	-	16	-	-	-

Notes: Sold in full bundles only. Product is shipped on skids. All measurements are nominal. [Read the Polymeric Sand advisory on Page 46.](#)

**Important:** Textured surfaces require a buffer between the plate compactor and the paver surface to prevent scuffing.

Internal Use Only, AVT OH

# BEACON HILL™ CLASSIC

NEW FOR 2019

## CLASSIC



SIERRA

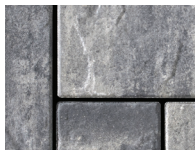

GRANITE



RIVER



LARGE RECTANGLE 21 1/4" x 14 1/8" x 2 3/8" 54cm x 36cm x 6cm  
 SQUARE 14 1/8" x 14 1/8" x 2 3/8" 36cm x 36cm x 6cm  
 SMALL RECTANGLE 7 1/16" x 14 1/8" x 2 3/8" 18cm x 36cm x 6cm

Random Bundle  
Individual units cannot be sold separately

Stones & Bundling	Unit Thickness	SqFt Per				Per Bundle		Soldier LnFt Per			Sailor LnFt per			Units Per			Lbs Per		
		Bundle	Layer	Section	Stone	Layers	Sections	SqFt	Section	Bundle	SqFt	Section	Bundle	SqFt	Section	Bundle	Layer	Section	Bundle
Random Bundle		93.62	-	-	-	9	-	-	-	-	-	-	-	-	-	72	281	-	2,530
Large Rectangle	2 3/8" (6cm)	-	-	-	-	-	-	-	-	-	-	-	-	-	-	18	-	-	-
Small Rectangle	2 3/8" (6cm)	-	-	-	-	-	-	-	-	-	-	-	-	-	-	27	-	-	-
Square	2 3/8" (6cm)	-	-	-	-	-	-	-	-	-	-	-	-	-	-	27	-	-	-

Notes: **Sold in full bundles only.** All measurements are nominal. **Important:** Textured surfaces require a buffer between the plate compactor and the paver surface to prevent scuffing. **6cm product is not intended for vehicular applications. \*8cm Thickness also available for special order - lead time required.**

**Please contact UniocK for more information.**

Internal Use Only, BHF OH

# BEACON HILL™ FLAGSTONE

ENDURACOLOR™



BIRCH



PLATINUM



RIVER



XL UNIT  
21 x 35 x 2 3/8"  
53 x 88 x 6cm  
SOLD SEPARATELY



SIERRA



SLATE BLUE



WALNUT



LARGE RECTANGLE  
21 1/4" x 14 1/8" x 2 3/8"  
54cm x 36cm x 6cm



SQUARE  
14 1/8" x 14 1/8" x 2 3/8"  
36cm x 36cm x 6cm



SMALL RECTANGLE  
7 1/16" x 14 1/8" x 2 3/8"  
18cm x 36cm x 6cm

Random Bundle  
Individual units cannot  
be sold separately

Stones & Bundling	Unit Thickness	SqFt Per				Per Bundle		Soldier LnFt Per			Sailor LnFt per			Units Per			Lbs Per		
		Bundle	Layer	Section	Stone	Layers	Sections	SqFt	Section	Bundle	SqFt	Section	Bundle	SqFt	Section	Bundle	Layer	Section	Bundle
Random Bundle		93.62	-	-	-	9	-	-	-	-	-	-	-	-	-	72	281	-	2,530
Large Rectangle	2 3/8" (6cm)	-	-	-	-	-	-	-	-	-	-	-	-	-	-	18	-	-	-
Small Rectangle	2 3/8" (6cm)	-	-	-	-	-	-	-	-	-	-	-	-	-	-	27	-	-	-
Square	2 3/8" (6cm)	-	-	-	-	-	-	-	-	-	-	-	-	-	-	27	-	-	-
XL Unit	2 3/8" (6cm)	94.16	-	-	-	9	-	-	-	-	-	-	-	-	-	18	-	-	2,584

Notes: Sold in full bundles only. Product is shipped on skids. **Read the Polymeric Sand advisory on Page 46. Important: Textured surfaces require a buffer between the plate compactor and the paver surface to prevent scuffing. Product is not intended for vehicular applications.** All measurements are nominal.

Internal Use Only. BHF OH

# BEACON HILL™ SMOOTH

NEW FOR 2019 ENDURACOLOR™

## SMOOTH



SIERRA



STEEL GREY



FOSSIL

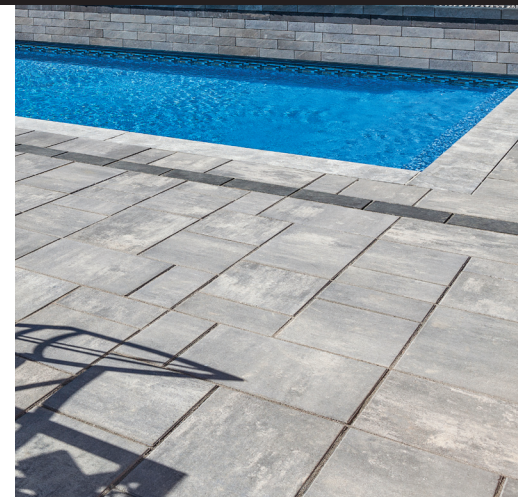



LARGE RECTANGLE  
21 1/4" x 14 1/8" x 2 3/8"  
54cm x 36cm x 6cm



SQUARE  
14 1/8" x 14 1/8" x 2 3/8"  
36cm x 36cm x 6cm



SMALL RECTANGLE  
7 1/16" x 14 1/8" x 2 3/8"  
18cm x 36cm x 6cm

Random Bundle  
Individual units cannot  
be sold separately



XL UNIT  
21 x 35 x 2 3/8"  
53 x 88 x 6cm  
SOLD SEPARATELY

Stones & Bundling	Unit Thickness	SqFt Per				Per Bundle		Soldier LnFt Per			Sailor LnFt per			Units Per			Lbs Per		
		Bundle	Layer	Section	Stone	Layers	Sections	SqFt	Section	Bundle	SqFt	Section	Bundle	SqFt	Section	Bundle	Layer	Section	Bundle
Random Bundle		93.62	-	-	-	9	-	-	-	-	-	-	-	-	-	72	281	-	2,530
Large Rectangle	2 3/8" (6cm)	-	-	-	-	-	-	-	-	-	-	-	-	-	-	18	-	-	-
Small Rectangle	2 3/8" (6cm)	-	-	-	-	-	-	-	-	-	-	-	-	-	-	27	-	-	-
Square	2 3/8" (6cm)	-	-	-	-	-	-	-	-	-	-	-	-	-	-	27	-	-	-
XL Unit	2 3/8" (6cm)	94.16	-	-	-	9	-	-	-	-	-	-	-	-	-	18	-	-	2,584

Notes: **Sold in full bundles only.** All measurements are nominal. **Important:** Textured surfaces require a buffer between the plate compactor and the paver surface to prevent scuffing. **6cm product is not intended for vehicular applications. \*8cm Thickness also available for special order - lead time required.** Please contact UniocK for more information.

Internal Use Only. BHF CH

# BOULEVARD

ENDURACOLOR™



RIVER

SIERRA

STEEL GREY



LARGE RECTANGLE  
24" x 12" x 2 3/4"  
61cm x 30.5cm x 7cm

MEDIUM RECTANGLE  
18" x 12" x 2 3/4"  
45.7cm x 30.5cm x 7cm

SQUARE  
12" x 12" x 2 3/4"  
30.5cm x 30.5cm x 7cm



Stones & Bundling	Unit Thickness	SqFt Per				Per Bundle		Soldier LnFt Per			Sailor LnFt per			Units Per			Lbs Per		
		Bundle	Layer	Section	Stone	Layers	Sections	SqFt	Section	Bundle	SqFt	Section	Bundle	SqFt	Section	Bundle	Layer	Section	Bundle
Random Bundle		93.00	-	-	-	8	-	-	-	-	-	-	-	-	-	64	373	-	2,978
Large Rectangle	2 3/4" (7cm)	-	-	-	-	-	-	-	-	-	-	-	-	-	-	24	-	-	-
Medium Rectangle	2 3/4" (7cm)	-	-	-	-	-	-	-	-	-	-	-	-	-	-	16	-	-	-
Square	2 3/4" (7cm)	-	-	-	-	-	-	-	-	-	-	-	-	-	-	24	-	-	-

Notes: Sold in full bundles only. Product is shipped on skids. [Read the Polymeric Sand advisory on Page 46.](#) **Important:** Textured surfaces require a buffer between the plate compactor and the paver surface to prevent scuffing. All measurements are nominal.

Internal Use Only. BRV CH

# BRISTOL VALLEY®

ENDURACOLOR™



BAVARIAN BLEND

COPPER RIDGE

STEEL MOUNTAIN

### TECHNICAL ADVANTAGE

#### EasyClean™ Stain Resistance - CF 90

An integral surface protection that allows for easier cleanup of spills when they happen, and before a stain can develop.



LARGE RECTANGLE  
21 1/4" x 14 1/8" x 2 3/8"  
54cm x 36cm x 6cm

SQUARE  
14 1/8" x 14 1/8" x 2 3/8"  
36cm x 36cm x 6cm

SMALL RECTANGLE  
7 1/16" x 14 1/8" x 2 3/8"  
18cm x 36cm x 6cm

Random Bundle  
Individual units cannot be sold separately



Stones & Bundling	Unit Thickness	SqFt Per				Per Bundle		Soldier LnFt Per			Sailor LnFt per			Units Per			Lbs Per		
		Bundle	Layer	Section	Stone	Layers	Sections	SqFt	Section	Bundle	SqFt	Section	Bundle	SqFt	Section	Bundle	Layer	Section	Bundle
Random Bundle		104.00	-	-	-	10	-	-	-	-	-	-	-	-	-	80	293	-	2,929
Large Rectangle	2 3/8" (6cm)	-	-	-	-	-	-	-	-	-	-	-	-	-	-	20	-	-	-
Small Rectangle	2 3/8" (6cm)	-	-	-	-	-	-	-	-	-	-	-	-	-	-	30	-	-	-
Square	2 3/8" (6cm)	-	-	-	-	-	-	-	-	-	-	-	-	-	-	30	-	-	-

Notes: Sold in full bundles only. Product is shipped on skids. [Read the Polymeric Sand advisory on Page 46.](#) **Important:** Textured surfaces require a buffer between the plate compactor and the paver surface to prevent scuffing. **Product is not intended for vehicular applications.** All measurements are nominal.

Internal Use Only. BRV CH

# BRUSSELS BLOCK®



COFFEE CREEK      LIMESTONE      SANDSTONE      SIERRA



**XL STONE**  
8¼" x 13¾" x 2¾"  
20.8cm x 34.8cm x 7cm



**STANDARD STONE**  
6⅞" x 8¼" x 2¾"  
17.3cm x 20.8cm x 7cm



**HALF STONE**  
4⅞" x 6⅞" x 2¾"  
10.4cm x 17.3cm x 7cm

Stones & Bundling	Unit Thickness	SqFt Per				Per Bundle		Soldier LnFt Per			Sailor LnFt per			Units Per			Lbs Per		
		Bundle	Layer	Section	Stone	Layers	Sections	SqFt	Section	Bundle	SqFt	Section	Bundle	SqFt	Section	Bundle	Layer	Section	Bundle
Half	2¾" (7cm)	88.70	-	12.67	0.198	8	7	0.580	-	152.86	0.347	-	255.75	5.05	64	448	-	393	2,752
Standard	2¾" (7cm)	88.60	-	12.66	0.396	8	7	0.693	-	127.87	0.580	-	152.86	2.53	32	224	-	393	2,749
XL	2¾" (7cm)	76.51	-	25.50	0.797	8	3	1.168	-	65.51	0.698	-	109.61	1.26	32	96	-	782	2,347

Notes: All measurements are nominal.

Internal Use Only. BBK OH

# CAMELOT™ & TUMBLED CAMELOT™



SIERRA CLASSIC & TUMBLED FINISH      RIVER CLASSIC & TUMBLED FINISH      COFFEE CREEK CLASSIC FINISH      GRANITE CLASSIC FINISH  
**NEW FOR 2019**



**LARGE RECTANGLE**  
6" x 9" x 2⅜"  
15cm x 22.5cm x 6cm



**SQUARE**  
6" x 6" x 2⅜"  
15cm x 15cm x 6cm



Stones & Bundling	Unit Thickness	SqFt Per				Per Bundle		Soldier LnFt Per			Sailor LnFt per			Units Per			Lbs Per		
		Bundle	Layer	Section	Stone	Layers	Sections	SqFt	Section	Bundle	SqFt	Section	Bundle	SqFt	Section	Bundle	Layer	Section	Bundle
Rectangle	2⅞" (6cm)	98.91	-	-	0.412	8	-	0.837	23.6	118.1	0.558	-	177.2	2.43	-	240	-	-	2,673
Square	2⅞" (6cm)	91.10	-	-	0.271	8	-	0.551	23.6	165.4	0.551	-	165.4	3.69	-	336	-	-	2,454
Rectangle *	3⅞" (8cm)	74.40	-	-	0.402	-	-	0.816	-	91.2	0.544	-	136.8	2.49	-	185	-	-	2,610
Square *	3⅞" (8cm)	81.20	-	-	0.276	-	-	0.561	-	144.7	0.561	-	144.7	3.62	-	294	-	-	2,730

Notes: \*3⅞" (8cm) thick units available by special order only. 8cm only in Classic. Minimum quantities apply. All measurements are nominal.

Internal Use Only. CAM OH





BURGUNDY RED



BURNT CLAY



OLD OAK



BURGUNDY RED/  
BURNT CLAY/OLD OAK  
Sold Separately/  
Blended on Site



BASALT



STEEL BLUE



STANDARD  
2½" x 7⅞" x 2⅜"  
6.5cm x 20cm x 6cm

**TECHNICAL ADVANTAGES**

**Reala™ Surface Technology**

Ultra-realistic textures cast from natural stone, brick and historic cobblestones.

**Ultima™ Concrete Technology**

This proprietary manufacturing process creates pavers and walls with up to four times the strength of poured concrete.



Stones & Bundling	Unit Thickness	SqFt Per				Per Bundle		Soldier LnFt Per			Sailor LnFt per			Units Per			Lbs Per		
		Bundle	Layer	Section	Stone	Layers	Sections	SqFt	Section	Bundle	SqFt	Section	Bundle	SqFt	Section	Bundle	Layer	Section	Bundle
2.5"x8"	2⅜" (6cm)	89.20	11.15	-	0.149	8	-	0.697	-	127.9	0.227	-	393.7	6.73	-	600	294	-	2,349

Notes: **Sold in full bundles only** on a refundable skid. All measurements are nominal. [Read the Polymeric Sand advisory on Page 46.](#)

**Important:** A urethane rubber paver mat must be used to prevent scuffing. Contact Unilock for information.

Internal Use Only. COP ON



BASALT



BELGIAN BLUE



DAWN MIST



PEBBLE TAUPE



BASALT/  
BELGIAN BLUE  
Sold Separately/  
Blended on Site



DAWN MIST/  
PEBBLE TAUPE  
Sold Separately/  
Blended on Site

**TECHNICAL ADVANTAGES**

**Reala™ Surface Technology**

Ultra-realistic textures cast from natural stone, brick and historic cobblestones.

**Ultima™ Concrete Technology**

This proprietary manufacturing process creates pavers and walls with up to four times the strength of poured concrete.



**XL RECTANGLE**  
5 1/8" x 8 3/8" x 2 3/8"  
13cm x 21.5cm x 6cm



**LG RECTANGLE**  
5 1/8" x 7 1/4" x 2 3/8"  
13cm x 18.5cm x 6cm



**RECTANGLE**  
5 1/8" x 6 1/2" x 2 3/8"  
13cm x 16.5cm x 6cm



**SM RECTANGLE**  
5 1/8" x 5 3/4" x 2 3/8"  
13cm x 14.5cm x 6cm



**SQUARE**  
5 1/8" x 5 1/8" x 2 3/8"  
13cm x 13cm x 6cm

Random Bundle  
Individual units cannot  
be sold separately

Stones & Bundling	Unit Thickness	SqFt Per				Per Bundle		Soldier LnFt Per			Sailor LnFt per			Units Per			Lbs Per		
		Bundle	Layer	Section	Stone	Layers	Sections	SqFt	Section	Bundle	SqFt	Section	Bundle	SqFt	Section	Bundle	Layer	Section	Bundle
Random Full Bundle		98.30	12.29	-	-	8	-	-	-	-	-	-	-	-	-	384	328	-	2,326
Large Rectangle	2 3/8" (6cm)	-	-	-	-	-	-	-	-	-	-	-	-	-	-	64	-	-	-
Rectangle	2 3/8" (6cm)	-	-	-	-	-	-	-	-	-	-	-	-	-	-	64	-	-	-
Small Rectangle	2 3/8" (6cm)	-	-	-	-	-	-	-	-	-	-	-	-	-	-	64	-	-	-
Square	2 3/8" (6cm)	-	-	-	-	-	-	-	-	-	-	-	-	-	-	64	-	-	-
XL Rectangle	2 3/8" (6cm)	-	-	-	-	-	-	-	-	-	-	-	-	-	-	128	-	-	-

Notes: \*Sold in full bundles only and is shipped on a refundable skid. All measurements are nominal. [Read the Polymeric Sand advisory on Page 46.](#)

**Important:** Textured surfaces require a buffer between the plate compactor and the paver surface to prevent scuffing. Contact Unilock for information.

Internal Use Only. CRT ON



NATURAL



RIVER



**STANDARD**  
10 1/4" x 10 1/4" x 3 1/8"  
26cm x 26cm x 8cm

**TECHNICAL ADVANTAGES**

**Permeable**

Can be installed to allow water to flow through.



Stones & Bundling	Unit Thickness	SqFt Per				Per Bundle		Soldier LnFt Per			Sailor LnFt per			Units Per			Lbs Per				
		Bundle	Layer	Section	Stone	Layers	Sections	SqFt	Section	Bundle	SqFt	Section	Bundle	SqFt	Section	Bundle	Layer	Section	Bundle		
Standard	3 1/8" (8cm)	84.40	-	-	0.502	8	-	-	-	-	-	-	-	-	-	1.99	-	168	-	-	2,818

Notes: Most standard colors are available but are special order only and subject to minimum quantities. Contact your representative for details. This product is optimized for mechanical installation. Available in full bundles only and is shipped on skids. All measurements are nominal. Contact Unilock for information.

Internal Use Only. EOP OH



Eco-Line is Special Order only.

				Individual units cannot be sold separately Random Bundle
14" x 3 5/16" x 4" (35.7cm x 8.4cm x 10cm)	12 1/2" x 3 5/16" x 4" (31.7cm x 8.4cm x 10cm)	11" x 3 5/16" x 4" (27.7cm x 8.4cm x 10cm)	9 3/8" x 3 5/16" x 4" (23.7cm x 8.4cm x 10cm)	
14" x 4 1/2" x 4" (35.7cm x 11.4cm x 10cm)	12 1/2" x 4 1/2" x 4" (31.7cm x 11.4cm x 10cm)	11" x 4 1/2" x 4" (27.7cm x 11.4cm x 10cm)	9 3/8" x 4 1/2" x 4" (23.7cm x 11.4cm x 10cm)	



Stones & Bundling	Unit Thickness	SqFt Per				Per Bundle		Soldier LnFt Per			Sailor LnFt per			Units Per			Lbs Per		
		Bundle	Layer	Section	Stone	Layers	Sections	SqFt	Section	Bundle	SqFt	Section	Bundle	SqFt	Section	Bundle	Layer	Section	Bundle
Random Bundle	4" (10cm)	66.20	11.03			6	-	-	-	-	-	-	-	-	144	504	-	3,027	

Notes: Special Order only - multiple finish and color options are available. Please contact your Unilock Territory Manager for further information. All measurements are nominal. **Important:** A urethane rubber paver mat must be used to prevent scuffing. Approved for vehicular applications

Internal Use Only. EOL ON



RIVER

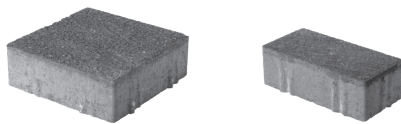

LARGE SQUARE  
10" x 10" x 3/8"  
24cm x 24cm x 8cm  
SPECIAL ORDER

RECTANGLE  
5" x 10" x 3/8"  
12cm x 24cm x 8cm

**TECHNICAL ADVANTAGES**

- Permeable**  
Can be installed to allow water to flow through.



Stones & Bundling	Unit Thickness	SqFt Per				Per Bundle		Soldier LnFt Per			Sailor LnFt per			Units Per			Lbs Per		
		Bundle	Layer	Section	Stone	Layers	Sections	SqFt	Section	Bundle	SqFt	Section	Bundle	SqFt	Section	Bundle	Layer	Section	Bundle
Rectangle **	3/8" (8cm)	75.95	-	-	-	7	-	-	-	-	-	-	-	-	217	-	-	2,669	
Large Square	3/8" (8cm)	86.6	-	-	-	7	-	-	-	-	-	-	-	-	140	-	-	3,099	

Notes: River is available in 5x10 as a stock item. \*\*5x10 bundles contain 56 5x5 units and 217 5x10 units: combined total sq.ft. is 75.95. Sold in full bundles only and is shipped on skids. Eco-Priora can be manufactured in a variety of custom colors and textures. Minimum quantities may apply. Specially graded aggregates must be used for the joints. Contact Unilock for information. All measurements are nominal.

Internal Use Only. EPA OH



PREMIER FINISH

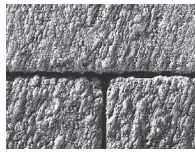

IL CAMPO® FINISH

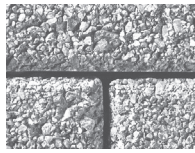

SERIES™ FINISH



UMBRIANO® FINISH



STANDARD FINISH



3 x 12 x 4"  
7.5 x 30 x 10cm  
**SPECIAL ORDER**



Stones & Bundling	Unit		SqFt Per				Per Bundle		Soldier LnFt Per			Sailor LnFt per			Units Per			Lbs Per		
	Thickness	Bundle	Layer	Section	Stone	Layers	Sections	SqFt	Section	Bundle	SqFt	Section	Bundle	SqFt	Section	Bundle	Layer	Section	Bundle	
3" x 12" Permeable	4" (10cm)	63.94	10.66	-	0.24	6	-	-	-	-	-	-	-	4.13	-	-	*	-	*	

Notes: **Sold in full bundles only and is produced and sold on a required, refundable skid.** Custom finish and color options are available. **Special order - lead time is required,** minimum quantities apply. \* indicates weights vary depending on plant of manufacture & finish. **Important: A urethane rubber paver mat must be used to prevent scuffing.** For permeable installations, Unilock recommends using granite chips for joint filler. All measurements are nominal. Contact Unilock for more information.

Internal Use Only. ECP CH



NOTTE



SABIA



 8 7/8 x 7 1/2 x 2 3/4" 22.5 x 18.8 x 7cm	 13 3/8 x 7 1/2 x 2 3/4" 34 x 18.8 x 7cm	 17 1/4 x 7 1/2 x 2 3/4" 45 x 18.8 x 7cm	 17 3/4 x 4 7/8 x 2 3/4" 45 x 12.5 x 7cm	Individual units cannot be sold separately <b>Random Bundle</b>
 6 3/4 x 4 7/8 x 2 3/4" 17 x 12.5 x 7cm	 10 3/8 x 4 7/8 x 2 3/4" 26 x 12.5 x 7cm	 13 3/8 x 4 7/8 x 2 3/4" 34 x 12.5 x 7cm		



HEX  
8 x 8 x 2 3/4"  
20 x 20 x 7cm  
**SOLD SEPARATELY**

Stones & Bundling	Unit		SqFt Per				Per Bundle		Soldier LnFt Per			Sailor LnFt per			Units Per			Lbs Per		
	Thickness	Bundle	Layer	Section	Stone	Layers	Sections	SqFt	Section	Bundle	SqFt	Section	Bundle	SqFt	Section	Bundle	Layer	Section	Bundle	
Artline Random Bundle		93.25	11.66		1,000	8	-	-	-	-	-	-	-	2.06	-	192	373	-	2,986	
Large 12.5	2 3/4" (7cm)	-	-	0.451	-	-	-	-	-	-	-	-	2.22	32	-	-	-	-		
Large 18.75	2 3/4" (7cm)	-	-	0.908	-	-	-	-	-	-	-	-	1.10	16	-	-	-	-		
Medium 12.5	2 3/4" (7cm)	-	-	0.353	-	-	-	-	-	-	-	-	2.83	32	-	-	-	-		
Medium 18.75	2 3/4" (7cm)	-	-	0.681	-	-	-	-	-	-	-	-	1.47	16	-	-	-	-		
Small 12.5	2 3/4" (7cm)	-	-	0.227	-	-	-	-	-	-	-	-	4.40	32	-	-	-	-		
Small 18.75	2 3/4" (7cm)	-	-	0.454	-	-	-	-	-	-	-	-	2.20	32	-	-	-	-		
X-Large 12.5	2 3/4" (7cm)	-	-	0.605	-	-	-	-	-	-	-	-	1.65	32	-	-	-	-		
City Park Hex Paver	2 3/4" (7cm)	73.92	-	-	-	-	-	-	-	-	-	-	-	-	-	-	-	-	2,450	

Notes: Sold in full bundles only on a refundable skid. Minimum quantities apply on custom orders. All measurements are nominal. **Important: A urethane rubber paver mat must be used to prevent scuffing.** Specially designed aggregates must be used for the joints. Contact your Unilock Territory Manager for further information.

Internal Use Only. GRA ON

# HOLLAND PREMIER™

# ENDURACOLOR™



MOCHA



DARK CHARCOAL



CREAM



HOLLAND PREMIER  
4" x 8" x 2½"  
10cm x 20cm x 6cm

Stones & Bundling	Unit Thickness	SqFt Per				Per Bundle		Soldier LnFt Per			Sailor LnFt per			Units Per			Lbs Per		
		Bundle	Layer	Section	Stone	Layers	Sections	SqFt	Section	Bundle	SqFt	Section	Bundle	SqFt	Section	Bundle	Layer	Section	Bundle
4" x 8"	2½" (6cm)	106.40	-	-	0.219	9	-	0.667	-	159.4	-	-	318.9	4.57	-	486	309	-	2,777

Notes: **\*Sold in full bundles only.** Read the **Polymeric Sand advisory on Page 46.** **Important:** Textured surfaces require a buffer between the plate compactor and the paver surface to prevent scuffing. All measurements are nominal.

Internal Use Only. HPR OH

# HOLLANDSTONE™



CHARCOAL



RUSTIC RED



COFFEE CREEK



RIVER

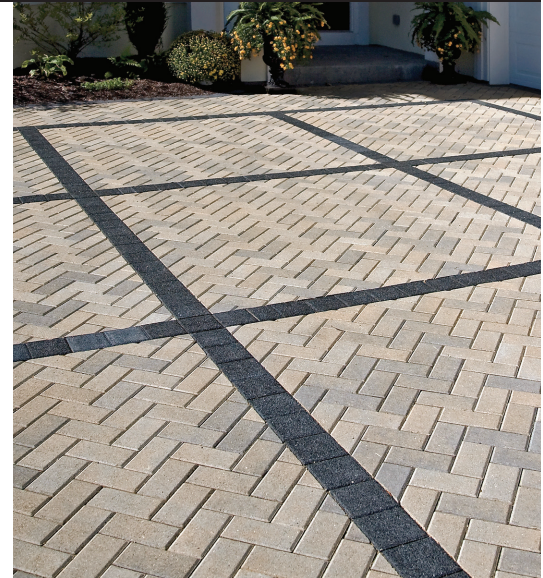

HOLLANDSTONE  
4" x 8" x 2½"  
10cm x 20cm x 6cm

Stones & Bundling	Unit Thickness	SqFt Per				Per Bundle		Soldier LnFt Per			Sailor LnFt per			Units Per			Lbs Per		
		Bundle	Layer	Section	Stone	Layers	Sections	SqFt	Section	Bundle	SqFt	Section	Bundle	SqFt	Section	Bundle	Layer	Section	Bundle
4"x8"	2½" (6cm)	106.40	-	17.73	0.219	9	6	-	26.6	159.4	0.334	-	318.9	4.57	81	486	-	463	2,777
4"x8"	3½" (8cm)	82.50	-	-	0.219	-	-	0.666	-	123.9	0.333	-	247.8	4.58	-	378	-	-	2,985

Notes: **\*8cm product is special order and subject to minimum quantities.** All measurements are nominal.

Internal Use Only. HOL OH

# IL CAMPO®

# ENDURACOLOR™



DARK CHARCOAL



MOCHA

ARTLINE SIZES AVAILABLE, SEE PAGE 2

## IL CAMPO® FINISH



PLATINUM BLEND



4" x 8" x 2 3/4"  
10cm x 20cm x 7cm

Stones & Bundling	Unit Thickness	SqFt Per				Per Bundle		Soldier LnFt Per			Sailor LnFt per			Units Per			Lbs Per		
		Bundle	Layer	Section	Stone	Layers	Sections	SqFt	Section	Bundle	SqFt	Section	Bundle	SqFt	Section	Bundle	Layer	Section	Bundle
4" x 8"	2 3/4" (7cm)	94.60	11.83	15.77	0.219	8	6	0.667	-	141.7	0.334	-	283.5	4.57	72	432	369	492	2,953
Artline Random Bundle		93.25	11.66	-	-	8	-	-	-	-	-	-	-	-	-	192	364	-	2,911
Unit A	2 3/4" (7cm)	-	-	-	-	-	-	-	-	-	-	-	-	-	-	32	-	-	-
Unit B	2 3/4" (7cm)	-	-	-	-	-	-	-	-	-	-	-	-	-	-	32	-	-	-
Unit C	2 3/4" (7cm)	-	-	-	-	-	-	-	-	-	-	-	-	-	-	32	-	-	-
Unit D	2 3/4" (7cm)	-	-	-	-	-	-	-	-	-	-	-	-	-	-	32	-	-	-
Unit E	2 3/4" (7cm)	-	-	-	-	-	-	-	-	-	-	-	-	-	-	32	-	-	-
Unit F	2 3/4" (7cm)	-	-	-	-	-	-	-	-	-	-	-	-	-	-	16	-	-	-
Unit G	2 3/4" (7cm)	-	-	-	-	-	-	-	-	-	-	-	-	-	-	16	-	-	-

Notes: Sold in full bundles only. Product is shipped on skids.\* Minimum quantities apply. All measurements are nominal. [Read the Polymeric Sand advisory on Page 46.](#)  
**Important:** Textured surfaces require a buffer between the plate compactor and the paver surface to prevent scuffing. Contact Unilock for information.

Internal Use Only. ILC ON

# MATTONI

# ENDURACOLOR™



DARK CHARCOAL



SABLE BLEND



CHARLESTON  
NEW FOR 2019



2 1/4" x 9 1/2" x 2 3/4"  
6cm x 24cm x 7cm

Stones & Bundling	Unit Thickness	SqFt Per				Per Bundle		Soldier LnFt Per			Sailor LnFt per			Units Per			Lbs Per		
		Bundle	Layer	Section	Stone	Layers	Sections	SqFt	Section	Bundle	SqFt	Section	Bundle	SqFt	Section	Bundle	Layer	Section	Bundle
2.25" x 9.5"	2 3/4" (7cm)	89.28	11.16	-	0.155	8	-	0.787	-	113.4	0.197	-	453.5	6.45	-	576	357	-	2,859

Notes: Sold in full bundles only. Product is shipped on skids. All measurements are nominal. [Read the Polymeric Sand advisory on Page 46.](#) **Important:** Textured surfaces require a buffer between the plate compactor and the paver surface to prevent scuffing. Contact Unilock for information.

Internal Use Only. MAT ON

# NATURAL STONE

## SANDSTONE



STONE  
CLIFF GREY



INDIAN COAST



BLACK RIVER



WINTER MIST

## LIMESTONE

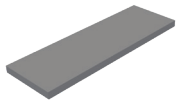
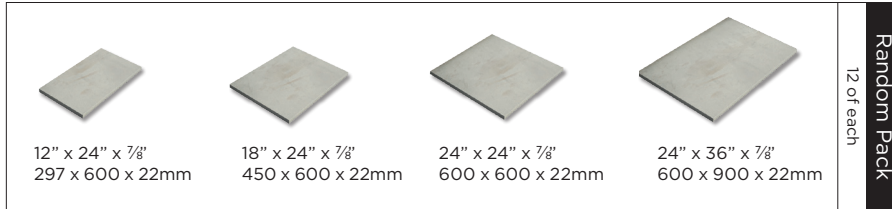

NATURAL EDGE COPING  
12" x 48" x 2" (12" x 36" x 2" - Winter Mist)  
300mm x 1200mm x 50.8cm  
(300mm x 900mm x 50.8cm)

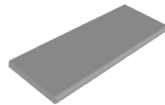

FULLNOSE COPING  
12" x 48" x 2" (12" x 36" x 2" - Winter Mist)  
300mm x 1200mm x 50.8cm  
(300mm x 900mm x 50.8cm)



PILLAR CAP  
24" x 24 x 2"  
600mm x 600mm x 50.8cm

Stones & Bundling	Unit Thickness	SqFt Per		LnFt Per		Units Per		Lbs Per	
		Crate	Stone	Unit	Crate	SqFt	Crate	Unit	Crate
24" x 24"	.87" (2.2cm)	160	4	-	-	0.26	40	46.28	1,851
24" x 36"	.87" (2.2cm)	180	6	-	-	0.17	30	69.40	2,082
Random Pack		174	2-6	-	-		48	22.4 - 71.6	2,265
12" x 24"	.87" (2.2cm)	22.6	2	-	-	0.52	12	-	-
18" x 24"	.87" (2.2cm)	34.7	3	-	-	0.34	12	-	-
24" x 24"	.87" (2.2cm)	46.5	4	-	-	0.26	12	-	-
24" x 36"	.87" (2.2cm)	70.2	6	-	-	0.17	12	-	-
12" x 36" Coping (Winter Mist)	2" (5cm)	-	-	3	90	-	30	80.83	2,425
12" x 48" Coping	2" (5cm)	-	-	4	80	-	20	105.8	2,116
12" x 48" Fullnose Coping	2" (5cm)	-	-	4	80	-	20	105.8	2,116
Pillar Cap - 24" x 24"	2" (5.1cm)	-	-	-	14	-	-	136.69	1,913.66

Notes: **Random Pack is sold in full crates only. 24" x 24", 24" x 36" and coping units area sold by the piece and can be cut down to match any of the sizes in the Random Pack.** Product is shipped on refundable skids.

# PORCELAIN TILE



ARBOR BIANCO



ARBOR GRAY



ARBOR NATURAL



LASCALA BEIGE



LASCALA GRAY



DOLOMITI BEIGE



DOLOMITI GREY



DOLOMITI NATURAL



DOLOMITI NOCE



EPOKAL BEIGE SCURO



EPOKAL BEIGE



EPOKAL GREY



GOTHAM BEIGE



GOTHAM GREY



GOTHAM NERO



TRAVSTONE BEIGE



TRAVSTONE NOCE



23<sup>3</sup>/<sub>8</sub> x 23<sup>3</sup>/<sub>8</sub> x <sup>3</sup>/<sub>4</sub>"  
60 x 60 x 2cm



15<sup>3</sup>/<sub>4</sub> x 31<sup>1</sup>/<sub>2</sub> x <sup>3</sup>/<sub>4</sub>"  
40 x 80 x 2cm

AVAILABLE IN EPOKAL,  
ARBOR AND LASCALA ONLY



16 x 48 x <sup>3</sup>/<sub>4</sub>"  
40 x 120 x 2cm

DOLOMITI ONLY

Stones & Bundling	Unit Thickness	SqFt Per			Boxes /Crate	Units Per		Lbs Per		
		Unit	Box	Crate		Box	Crate	SqFt	Box	Crate
Arbor (40 x 80cm) 16" x 32"	.75" (2cm)	3.445	6.89	165.36	24	2	48	9.04	62.3	1,541
LaScala (40 x 80cm) 16" x 32"	.75" (2cm)	3.445	6.89	165.36	24	2	48	9.04	62.3	1,541
Dolomiti (40 x 120cm) 16" x 48"	.75" (2cm)	5.17	5.17	279.18	54	1	54	9	47.30	2,800
Epokal (40 x 80cm) 16" x 32"	.75" (2cm)	3.445	6.89	165.36	24	2	48	9.04	62.3	1,541
Gotham (60 x 60cm) 24" x 24"	.75" (2cm)	3.875	-	255.76	-	-	66	9.23	-	2,360
Travstone (60 x 60cm) 24" x 24"	.75" (2cm)	3.875	-	255.76	-	-	66	9.23	-	2,360

Notes: **Stock items sold in full crates or by the piece. Special order items sold in full crates only.** Product is shipped on a refundable skid. For pedestal applications, please contact your Unilock Territory Manager.



# OPTILOC®



NATURAL



STANDARD  
10<sup>1</sup>/<sub>4</sub>" x 10<sup>1</sup>/<sub>4</sub>" x 3<sup>1</sup>/<sub>8</sub>"  
26cm x 26cm x 8cm  
**SPECIAL ORDER**

CUSTOM COLORS & FINISHES AVAILABLE



STANDARD FINISH

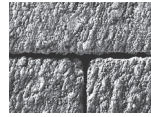

BRUSHED FINISH



WASHED FINISH



Stones & Bundling	Unit Thickness	SqFt Per				Per Bundle		Soldier LnFt Per			Sailor LnFt per			Units Per			Lbs Per		
		Bundle	Layer	Section	Stone	Layers	Sections	SqFt	Section	Bundle	SqFt	Section	Bundle	SqFt	Section	Bundle	Layer	Section	Bundle
Standard	3 <sup>1</sup> / <sub>8</sub> " (8cm)	77.33	-	-	0.537	-	-	-	-	-	-	-	-	1.86	-	144	-	-	2,801

Notes: **\*Available by special order only.** Minimum quantities apply. Optiloc can be manufactured in a variety of custom colors and textures. Minimum quantities may apply. Contact Unilock for information. This product is optimized for mechanical installation. Full bundles only. Product is shipped on skids. All measurements are nominal.

Internal Use Only. OPL OH

# PROMENADE™ PLANK PAVER

# ENDURACOLOR®



OPAL BLEND  
4"X16"  
8"X24"



STEEL GREY BLEND  
4"X16"  
8"X24"



GRANITE BLEND  
IL CAMPO FINISH  
4"X12"  
8"X24"



ONYX BLACK  
SERIES FINISH  
4"X12"  
8"X24"



SANDSTONE  
**NEW FOR 2019**  
4"X12"



8" x 24" x 4"  
(20cm x 60cm x 10cm)



4" x 16" x 4"  
(10cm x 40cm x 10cm)



4" x 12" x 4"  
(10cm x 30cm x 10cm)



Stones & Bundling	Unit Thickness	SqFt Per				Per Bundle		Soldier LnFt Per			Sailor LnFt per			Units Per			Lbs Per		
		Bundle	Layer	Section	Stone	Layers	Sections	SqFt	Section	Bundle	SqFt	Section	Bundle	SqFt	Section	Bundle	Layer	Section	Bundle
8" x 24"	4" (10cm)	51.67	10.33		1.292	5	-	-	-	-	-	-	0.77	-	40	478	-	2,391	
4" x 16"	4" (10cm)	51.67	10.33		0.431	5	-	-	-	-	-	-	2.32	-	120	488	-	2,440	
4" x 12"	4" (10cm)	58.13	11.63		0.323	5	-	-	-	-	-	-	3.10	-	180	532	-	2,659	

Notes: Sold in full bundles only on a refundable skid. **Important: A urethane rubber paver mat must be used to prevent scuffing.** Read the Polymeric Sand advisory on page 46. Contact your Unilock Territory Manager for further information. All measurements are nominal.

Internal Use Only. PMD ON



DAWN MIST



PEBBLE TAUPE







DAWN MIST/  
PEBBLE TAUPE  
Sold Separately/  
Blended on Site

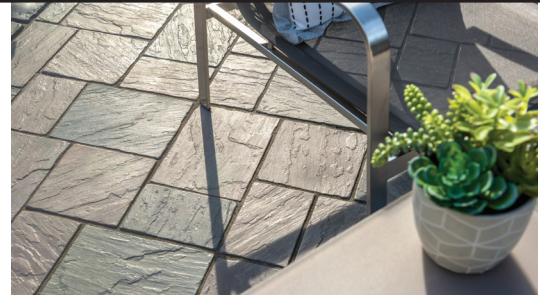

SMOKE SHALE



			Random Bundle Individual units cannot be sold separately.	
RECTANGLE 12" x 9" x 2 3/8" 30cm x 22.6cm x 6cm	SQUARE 9" x 9" x 2 3/8" 22.6cm x 22.6cm x 6cm	SMALL RECTANGLE 6" x 9" x 2 3/8" 15cm x 22.6cm x 6cm		LARGE RECTANGLE 21 x 12 x 2 3/8" 52.8 x 30.2 x 6cm SOLD SEPARATELY

**TECHNICAL ADVANTAGES**

**Reala™ Surface Technology**

Ultra-realistic textures cast from natural stone, brick and historic cobblestones.

**Ultima™ Concrete Technology**

This proprietary manufacturing process creates pavers and walls with up to four times the strength of poured concrete.

Stones & Bundling	Unit Thickness	SqFt Per				Per Bundle		Soldier LnFt Per			Sailor LnFt per			Units Per			Lbs Per		
		Bundle	Layer	Section	Stone	Layers	Sections	SqFt	Section	Bundle	SqFt	Section	Bundle	SqFt	Section	Bundle	Layer	Section	Bundle
Random Bundle		90.30	11.29			8	-	-	-	-	0.673	-	134.2	1.77	-	160	309	-	2,472
Large Rectangle	2 3/8" (6cm)	46.71	-	-	0.730	-	-	-	-	-	0.741		63.0	1.37	-	64	-	-	-
Small Rectangle	2 3/8" (6cm)	23.35	-	-	0.365	-	-	-	-	-	0.492		47.5	2.74	-	64	-	-	-
Square	2 3/8" (6cm)	17.59	-	-	0.550	-	-	-	-	-	0.741		23.7	1.82	-	32	-	-	-
Large Rectangle	2 3/8" (6cm)	82.39	-	-	1.716	-	-	-	-	-	-		-	-	-	48	-	-	2,410

Notes: Sold in full bundles only. Product is shipped on skids. All measurements are nominal. [Read the Polymeric Sand advisory on Page 46.](#)

**Important:** Textured surfaces require a buffer between the plate compactor and the paver surface to prevent scuffing. Contact Unilock for information.

Internal Use Only. RIC ON



BLUESTONE



CANYON

**TECHNICAL ADVANTAGES**

**Reala™ Surface Technology**

Ultra-realistic textures cast from natural stone, brick and historic cobblestones.



24" x 24" x 1 3/4"  
60cm x 60cm  
x 4.5cm



18" x 24" x 1 3/4"  
45cm x 60cm  
x 4.5cm



12" x 24" x 1 3/4"  
30cm x 60cm  
x 4.5cm

Stones & Bundling	Unit Thickness	SqFt Per				Per Bundle		Soldier LnFt Per			Sailor LnFt per			Units Per			Lbs Per			
		Bundle	Layer	Section	Stone	Layers	Sections	SqFt	Section	Bundle	SqFt	Section	Bundle	SqFt	Section	Bundle	Layer	Section	Bundle	
12" x 24"	1 3/4" (4.5cm)	36.00	-	-	2.000	-	-	-	-	-	-	-	-	-	0.50	-	18	-	-	712
18" x 24"	1 3/4" (4.5cm)	54.00	-	-	3.000	-	-	-	-	-	-	-	-	-	0.33	-	18	-	-	1,013
24" x 24"	1 3/4" (4.5cm)	72.00	-	-	4.000	-	-	-	-	-	-	-	-	-	0.25	-	18	-	-	1,321

Notes: Rivenstone™ is packaged on a specially designed refundable skid. Do not use a vibratory plate compactor for the final surface compaction.

**Product is not intended for vehicular applications.** All measurements are nominal. [Read the Polymeric Sand advisory on Page 46.](#)

Internal Use Only. RIV CH



CASTANO



CREMO



NUVOLA



RECTANGLE  
8" x 16" x 2 3/4"

20.8cm x 41.6cm x 7cm



SQUARE  
8" x 8" x 2 3/4"

20.8cm x 20.8cm x 7cm

**TECHNICAL ADVANTAGE**

**EasyClean™ Stain Resistance - CF 90**

An integral surface protection that allows for easier cleanup of spills when they happen, and before a stain can develop.



Stones & Bundling	Unit Thickness	SqFt Per				Per Bundle		Soldier LnFt Per			Sailor LnFt per			Units Per			Lbs Per		
		Bundle	Layer	Section	Stone	Layers	Sections	SqFt	Section	Bundle	SqFt	Section	Bundle	SqFt	Section	Bundle	Layer	Section	Bundle
8"x16"	2 3/4" (7cm)	82.67	10.33		0.861	8	-	1.312	-	63.0	0.656	-	126.0	1.16	-	96	-	-	2,647
8"x8"	2 3/4" (7cm)	82.67	10.33		0.431	8	-	0.656	-	126.0	0.656	-	126.0	2.32	-	192	-	-	2,647

Notes: Sold in full bundles only. Product is shipped on skids. All measurements are nominal. [Read the Polymeric Sand advisory on Page 46.](#)

**Important:** Textured surfaces require a buffer between the plate compactor and the paver surface to prevent scuffing.

Internal Use Only. SZO ON



COBALT GREY  
Available in Random bundle only



GOLDEN TAN  
Available in 4x8 only



MINERAL ICE GREY  
Available in 4x8 and Random bundle



ONYX BLACK  
Available in 4x8 only



4" x 8" x 2 3/4"  
10cm x 20cm x 7cm



21 1/4" x 14 1/8" x 2 3/8"  
54cm x 36cm x 6cm



14 1/8" x 14 1/8" x 2 3/8"  
36cm x 36cm x 6cm



7 1/16" x 14 1/8" x 2 3/8"  
18cm x 36cm x 6cm

Random Bundle  
Individual units cannot be sold separately

Random bundle available in Mineral Ice Grey and Cobalt Grey only

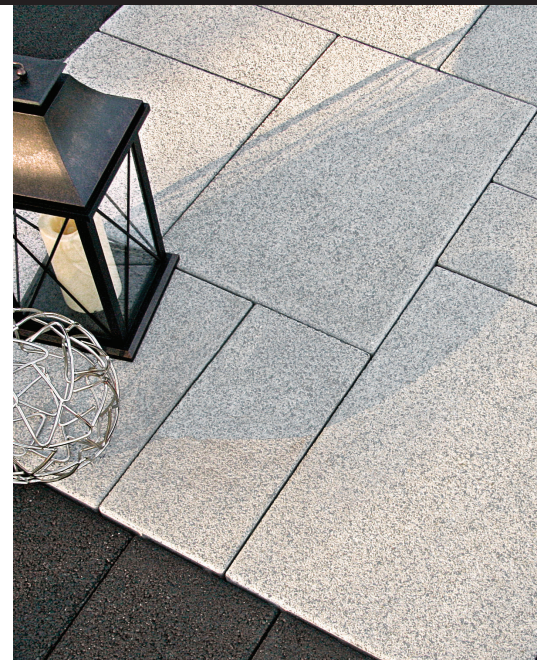

Stones & Bundling	Unit Thickness	SqFt Per				Per Bundle		Soldier LnFt Per			Sailor LnFt per			Units Per			Lbs Per		
		Bundle	Layer	Section	Stone	Layers	Sections	SqFt	Section	Bundle	SqFt	Section	Bundle	SqFt	Section	Bundle	Layer	Section	Bundle
<b>6cm Random Bundle</b> <small>(stocked in Cobalt Grey &amp; Mineral Ice Grey only)</small>		104.00	10.40	-	-	10	-	-	-	-	-	-	-	0.77	-	80.00	290	-	2,896
Large Rectangle	2 3/8" (6cm)	-	-	-	2.09	-	-	-	-	-	-	-	-	0.48	-	20.00	-	-	-
Square	2 3/8" (6cm)	-	-	-	1.40	-	-	-	-	-	-	-	-	0.72	-	30.00	-	-	-
Small Rectangle	2 3/8" (6cm)	-	-	-	0.70	-	-	-	-	-	-	-	-	1.43	-	30.00	-	-	-
4" x 8"	2 3/8" (7cm)	106.11	11.79	17.69	0.22	9	6	0.67	26.58	159.45	0.33	53.15	318.90	4.58	81	486.01	398	597	3,581

Notes: Custom colors and finishes available. Minimum quantities apply. See terms and conditions. All measurements are nominal. [Read the Polymeric Sand advisory on Page 46.](#) **Important:** Textured surfaces require a buffer between the plate compactor and the paver surface to prevent scuffing.

Internal Use Only. S3K CH

# SKYLINE™

**NEW FOR 2019 ENDURACOLOR™**



SILVER GREY



CREAM



24" x 24" x 2"  
60cm x 60cm x 5cm

PERFECT FOR  
ROOF DECKS AND  
OTHER RAISED  
FLOOR APPLICATIONS



Stones & Bundling	Unit Thickness	SqFt Per				Per Bundle		Soldier LnFt Per			Sailor LnFt per			Units Per			Lbs Per			
		Bundle	Layer	Section	Stone	Layers	Sections	SqFt	Section	Bundle	SqFt	Section	Bundle	SqFt	Section	Bundle	Layer	Section	Bundle	
24" x 24"	2" (5cm)	77.5	8.0		4.0	10	-	-	-	-	-	-	-	-	.25	-	20	182	-	1,869

Notes: Sold in full bundles only on a refundable skid. Minimum quantities apply on custom orders. All measurements are nominal. Contact your Unilock Territory Manager for further information.

Internal Use Only. SKY ON

# STONEHENGE®



RIVER



SIERRA



LARGE SQUARE  
12" x 12" x 2 3/4"  
30cm x 30cm x 7cm



RECTANGLE  
6" x 12" x 2 3/4"  
15cm x 30cm x 7cm



SMALL SQUARE  
6" x 6" x 2 3/4"  
15cm x 15cm x 7cm



Stones & Bundling	Unit Thickness	SqFt Per				Per Bundle		Soldier LnFt Per			Sailor LnFt per			Units Per			Lbs Per		
		Bundle	Layer	Section	Stone	Layers	Sections	SqFt	Section	Bundle	SqFt	Section	Bundle	SqFt	Section	Bundle	Layer	Section	Bundle
12" x 12"	2 3/4" (7cm)	93.04	-	23.26	0.969	8	4	0.985	23.6	94.5	0.985	-	94.5	1.03	24	96	-	713	2,852
6" x 12"	2 3/4" (7cm)	93.93	-	23.48	0.489	8	4	0.994	23.6	94.5	0.497	-	189.0	2.04	48	192	-	708	2,833
6" x 6"	2 3/4" (7cm)	93.04	-	11.63	0.242	8	8	0.492	23.6	189.0	0.492	-	189.0	4.13	48	384	-	351	2,808

Notes: All measurements are nominal.

Internal Use Only. STH OH



BAVARIAN



SIERRA

**TECHNICAL ADVANTAGES**

**Permeable**  
Can be installed to allow water to flow through.

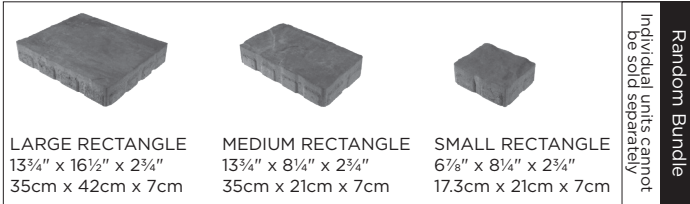

**LARGE RECTANGLE**  
13¾" x 16½" x 2¾"  
35cm x 42cm x 7cm

**MEDIUM RECTANGLE**  
13¾" x 8¼" x 2¾"  
35cm x 21cm x 7cm

**SMALL RECTANGLE**  
6⅞" x 8¼" x 2¾"  
17.3cm x 21cm x 7cm

Random Bundle  
Individual units cannot be sold separately

Stones & Bundling	Unit Thickness	SqFt Per				Per Bundle		Soldier LnFt Per			Sailor LnFt per			Units Per			Lbs Per		
		Bundle	Layer	Section	Stone	Layers	Sections	SqFt	Section	Bundle	SqFt	Section	Bundle	SqFt	Section	Bundle	Layer	Section	Bundle
Random Bundle		88.61	11.08	-	-	8	-	-	-	-	-	-	-	-	-	96	330	-	2,638
Large Rectangle	2¾" (7cm)	-	-	-	-	-	-	-	-	-	-	-	-	-	-	32	-	-	-
Medium Rectangle	2¾" (7cm)	-	-	-	-	-	-	-	-	-	-	-	-	-	-	32	-	-	-
Small Rectangle	2¾" (7cm)	-	-	-	-	-	-	-	-	-	-	-	-	-	-	32	-	-	-

Notes: Sold in full bundles only on a refundable skid. Contact Unilock for information. All measurements are nominal. **Read the Polymeric Sand advisory on Page 46. Important: Textured surfaces require a buffer between the plate compactor and the paver surface to prevent scuffing.**

Internal Use Only. THB OH



BURGUNDY RED



BURNT CLAY



OLD OAK



3 COLOR BLEND  
Blended on Site



BASALT



HERITAGE RED



HERITAGE CLAY



HERITAGE 2 COLOR BLEND  
Blended on Site



**TECHNICAL ADVANTAGES**

**Reala™ Surface Technology**  
Ultra-realistic textures cast from natural stone, brick and historic cobblestones.

**Ultima™ Concrete Technology**  
This proprietary manufacturing process creates pavers and walls with up to four times the strength of poured concrete.



**STANDARD**  
4" x 9¾" x 2¾"  
10cm x 25cm x 7cm

Stones & Bundling	Unit Thickness	SqFt Per				Per Bundle		Soldier LnFt Per			Sailor LnFt per			Units Per			Lbs Per		
		Bundle	Layer	Section	Stone	Layers	Sections	SqFt	Section	Bundle	SqFt	Section	Bundle	SqFt	Section	Bundle	Layer	Section	Bundle
Rectangle	2¾" (7cm)	88.41	11.05	-	0.276	8	-	0.842	-	105.0	0.337	-	262.5	3.62	-	320	364	-	2,888

Notes: Sold in full bundles only on a refundable skid. All measurements are nominal. **Read the Polymeric Sand advisory on Page 46. Important: A urethane rubber paver mat must be used to prevent scuffing.** Contact Unilock for information.

Internal Use Only. TWH ON

# TREO® PREMIER

ENDURACOLOR™



RIVER



SIERRA



WALNUT



LARGE RECTANGLE  
13¼" x 8⅞" x 2⅝"  
(33.75cm x 22.5cm x 6cm)



SQUARE  
8⅞" x 8⅞" x 2⅝"  
(22.5cm x 22.5cm x 6cm)



SMALL RECTANGLE  
4½" x 8⅞" x 2⅝"  
(11.25cm x 22.5cm x 6cm)

Individual units cannot be sold separately

Random Bundle

Stones & Bundling	Unit Thickness	SqFt Per				Per Bundle		Soldier LnFt Per			Sailor LnFt per			Units Per			Lbs Per		
		Bundle	Layer	Section	Stone	Layers	Sections	SqFt	Section	Bundle	SqFt	Section	Bundle	SqFt	Section	Bundle	Layer	Section	Bundle
Random Full Bundle:		94.32	-	-	-	9	-	-	-	-	-	-	-	-	216	285	-	2,562	
Large Rectangle	2⅝" (6cm)	-	-	-	-	-	-	-	-	-	-	-	-	-	45	-	-	-	
Small Rectangle	2⅝" (6cm)	-	-	-	-	-	-	-	-	-	-	-	-	-	117	-	-	-	
Square	2⅝" (6cm)	-	-	-	-	-	-	-	-	-	-	-	-	-	54	-	-	-	

Notes: **Sold in full bundles only** on a refundable skid. All measurements are nominal. **Read the Polymeric Sand advisory on Page 46. Important: Textured surfaces require a buffer between the plate compactor and the paver surface to prevent scuffing.** Contact Unilock for information.

Internal Use Only. TRO OH

# TRIBECA COBBLE



ENDURACOLOR™



CRYSTALLINE BASALT



PEPPERED GRANITE

### TECHNICAL ADVANTAGES

**Permeable**  
Can be installed to allow water to flow through.



LARGE RECTANGLE  
5⅞" x 12" x 2¾"  
(13cm x 30.5cm x 7cm)



RECTANGLE  
5⅞" x 9" x 2¾"  
(13cm x 23cm x 7cm)



SMALL RECTANGLE  
5⅞" x 7" x 2¾"  
(13cm x 17.5cm x 7cm)

Individual units cannot be sold separately

Random Bundle

Stones & Bundling	Unit Thickness	SqFt Per				Per Bundle		Soldier LnFt Per			Sailor LnFt per			Units Per			Lbs Per		
		Bundle	Layer	Section	Stone	Layers	Sections	SqFt	Section	Bundle	SqFt	Section	Bundle	SqFt	Section	Bundle	Layer	Section	Bundle
Random Bundle		97.53	12.19			8	-	-	-	129.7	-	-	-	-	-	304	398	-	3,186
Large Rectangle	2¾" (7cm)	-	-	-	0.427	-	-	1.001		37.5	-	-	-	2.34		88	-	-	-
Rectangle	2¾" (7cm)	-	-	-	0.322	-	-	0.755		37.5	-	-	-	3.11		88	-	-	-
Small Rectangle	2¾" (7cm)	-	-	-	0.245	-	-	0.574		54.6	-	-	-	4.08		128	-	-	-
Tribeca Curb																			

Notes: **Sold in full bundles only.** All measurements are nominal. **Important: Textured surfaces require a buffer between the plate compactor and the paver surface to prevent scuffing.** **Read the Polymeric Sand advisory on Page 46.** Contact Unilock for information.

Internal Use Only. TRC NY

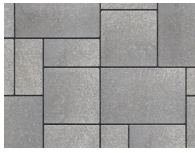

FRENCH GREY

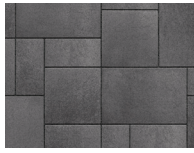

MIDNIGHT SKY



WINTER MARVEL



SUMMER WHEAT



**TECHNICAL ADVANTAGES**

**EasyClean™ Stain Resistance - CF 90**

An integral surface protection that allows for easier cleanup of spills when they happen, and before a stain can develop.

**ColorFusion™ Technology**

A proprietary technology that disperses color randomly for a natural, granite-like appearance.

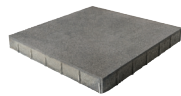

24" x 24" x 2¾"  
60cm x 60cm x 7cm



12" x 24" x 2¾"  
30cm x 60cm x 7cm

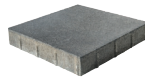

16" x 16" x 2¾"  
40cm x 40cm x 7cm



8" x 16" x 2¾"  
20cm x 40cm x 7cm



4" x 8" x 2⅜"  
10cm x 20cm x 6cm



LARGE RECTANGLE  
21" x 14" x 2⅜"  
30cm x 22.6cm x 6cm



SQUARE  
14" x 14" x 2⅜"  
22.6cm x 22.6cm x 6cm



SMALL RECTANGLE  
7" x 14" x 2⅜"  
15cm x 22.6cm x 6cm

Random Bundle  
Individual units cannot  
be sold separately



SMALL RECTANGLE  
7" x 14" x 3⅛"  
15cm x 22.6cm x 8cm

SOLD SEPARATELY  
SPECIAL ORDER ONLY

**RANDOM BUNDLE - NOW AVAILABLE IN BOTH 6CM & 8CM  
8CM SPECIAL ORDER ONLY**

Stones & Bundling	Unit Thickness	SqFt Per				Per Bundle		Soldier LnFt Per			Sailor LnFt per			Units Per			Lbs Per		
		Bundle	Layer	Section	Stone	Layers	Sections	SqFt	Section	Bundle	SqFt	Section	Bundle	SqFt	Section	Bundle	Layer	Section	Bundle
Random Bundle:		93.62	-	-	-	-	-	-	-	-	-	-	-	0.77	-	72	-	-	2,584
Large Rectangle	2⅜" (6cm)	-	-	-	2.093	-	-	-	-	-	-	-	-	0.48	-	18	-	-	-
Small Rectangle	2⅜" (6cm)	-	-	-	0.698	-	-	-	-	-	-	-	-	1.43	-	27	-	-	-
Square	2⅜" (6cm)	-	-	-	1.395	-	-	-	-	-	-	-	-	0.72	-	27	-	-	-
Random Bundle 8cm		73.24	10.46			7	-	-	-	-	0.985	-	74.4	0.77	-	56	383	-	2,680
Large Rectangle	3⅛" (8cm)	-	-	-	2.089	-	-	-	-	-	1.181		24.8	0.48		14	-	-	-
Small Rectangle	3⅛" (8cm)	-	-	-	0.698	-	-	-	-	-	0.591		24.8	1.43		21	-	-	-
Square	3⅛" (8cm)	-	-	-	1.395	-	-	-	-	-	1.181		24.8	0.72		21	-	-	-
4" x 8"	2⅜" (6cm)	106.11	11.79	17.69	0.22	9	6	0.67	26.58	159.45	0.33	53.15	316.9	4.58	81.0	486.01	322	483	2,900
8" x 16"	2¾" (7cm)	82.67	-	-	0.861	-	-	1.312	-	63.0	0.656	-	126.0	1.16	-	96	-	-	2,746
16" x 16"	2¾" (7cm)	82.67	-	-	1.722	-	-	1.312	-	63.0	1.312	-	63.0	0.58	-	48	-	-	2,797
12" x 24"	2¾" (7cm)	93.00	-	-	1.938	-	-	1.969	-	47.2	0.984	-	94.5	0.52	-	48	-	-	3,142
24" x 24"	2¾" (7cm)	62.00	-	-	3.875	-	-	1.969	-	31.5	1.969	-	31.5	0.26	-	16	-	-	2,062
7" x 14"	3⅛" (8cm)	73.24			0.698	7		1.181		62	0.059		124	1.43		105	383		2,680

Notes: Sold in full bundles only. All measurements are nominal. Product is not sectionable. Product is shipped on skids. 24" x 24", 12" x 24" and 6cm Random Bundle are not intended for vehicular applications. **Important: Textured surfaces require a buffer between the plate compactor and the paver surface to prevent scuffing.** Read the Polymeric Sand advisory on Page 46. Contact Unilock for information.

Internal Use Only. UMB ON

# TURFSTONE™



STANDARD  
16" x 24" x 3 1/8"  
40cm x 60cm x 8cm



NATURAL

Stones & Bundling	Unit Thickness	SqFt Per				Per Bundle		Soldier LnFt Per			Sailor LnFt per			Units Per			Lbs Per		
		Bundle	Layer	Section	Stone	Layers	Sections	SqFt	Section	Bundle	SqFt	Section	Bundle	SqFt	Section	Bundle	Layer	Section	Bundle
16"X24"	3 1/8" (8cm)	70.00	-	-	2.500	-	-	-	-	-	-	-	-	0.40	-	28	-	-	1,649

Notes: Sold in full bundles only on a refundable skid. Do not use a plate compactor on Turfstone™. All measurements are nominal.

Internal Use Only. TFS ON

# UNIGRANITE®



SMALL SQUARE  
4" x 4" x 2 3/4"  
10cm x 10cm x 7cm



DARK CHARCOAL

Stones & Bundling	Unit Thickness	SqFt Per				Per Bundle		Soldier LnFt Per			Sailor LnFt per			Units Per			Lbs Per		
		Bundle	Layer	Section	Stone	Layers	Sections	SqFt	Section	Bundle	SqFt	Section	Bundle	SqFt	Section	Bundle	Layer	Section	Bundle
4" x 4"	2 3/4" (7cm)	110.70	-	13.84	0.110	7	8	0.335	41.3	330.7	0.335	-	330.7	9.11	126	1,008	-	435	3,481

Notes: \*After splitting. Dimensions may vary up to 1/4" due to the unique manufacturing method. Instead of a split finish, Unigranite can be cut and sealed to provide a Terrazzo-like finish. [Read the Polymeric Sand advisory on Page 46.](#) All measurements are nominal.

Internal Use Only. UGT ON



# BRUSSELS DIMENSIONAL SYSTEM™



COFFEE CREEK



LIMESTONE



RIVER \*



SANDSTONE



SIERRA



BROWN

Brown available in Standard/Corner only, while quantities last.



SMALL TAPERED UNIT  
9" (6") x 4" x 8"  
22.9cm (15.2cm) x 10cm x 20cm



STANDARD/CORNER  
12" x 4" x 8"  
30cm x 10cm x 20cm



COPING  
12" (9") x 3" x 12"  
30.5cm (22.9cm) x 7.6cm x 30.5cm

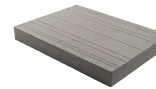

UNIVERSAL BASE UNIT  
19" x 14" x 2"  
48.2cm x 35.5cm x 5.5cm



9" UNIT  
9" (6") x 4" x 8"  
22.9cm (15.2cm) x 10cm x 20cm



12" UNIT  
12" (9") x 4" x 8"  
30cm (22.9cm) x 10cm x 20cm



15" UNIT  
15" (12") x 4" x 8"  
38.1cm (30cm) x 10cm x 20cm

Wall Bundle  
Individual units cannot be sold separately

### SUNSET FIREPIT KITS

Available Colors: Coffee Creek, Limestone, Sandstone, Sierra and River.



Round



Square

Stones & Bundling	Face Feet Per		Linear Feet Per		Units Per		Per Bundle		Lbs Per	
	Bundle	Unit	Bundle	Unit	Bundle	Face Feet	Layers	Sections	Unit	Bundle
Coping	24.00	0.250	81.00	0.844	96	4.00	-	4	31	2,984
Universal Base Unit	-	-	95	1.58	60	-	-	-	46.93	2,816
Standard / Corner	24 - 36	0.278	108.00	1.000	108	3.60	-	6	29	3,182
Wall Tapered	36.00	-	108.00	-	108	-	-	6	-	2,737
12" Unit	12.00	0.323	35.42	0.984	36	3.10	-	-	25.8	-
15" Unit	15.00	0.410	45.00	1.250	36	2.44	-	-	32.2	-
9" Unit	9.00	0.246	27.04	0.751	36	4.06	-	-	19.3	-
Wall Small Tapered	36.00	0.250	108.00	0.750	144	4.00	-	-	20	2,880

Notes: \*Coping not available in River. Small Tapered Bundle is sold in full bundles only. Ask for connector pins for random bundle product when ordering. Maximum height 27" with setback or 24" vertically including the unit in the ground (depending on site conditions). To construct higher walls, contact a Unilock representative. For coping options we recommend using Natural Stone or LedgeStone. Product will only be sold in full bundles or sections. All measurements are nominal.

Internal Use Only. BDS OH

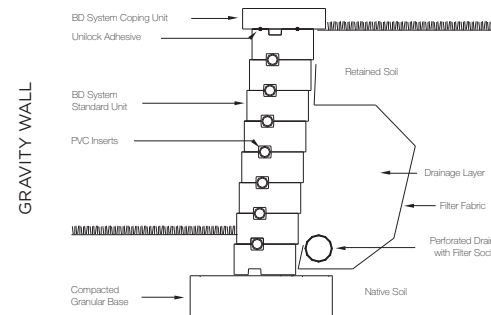
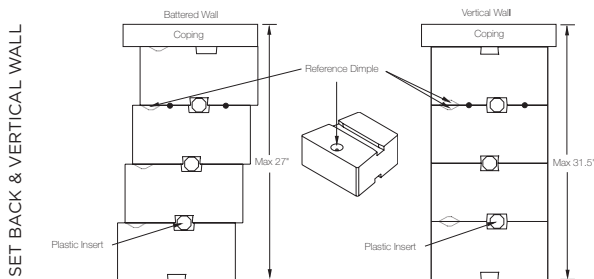

## BRUSSELS DIMENSIONAL SYSTEM™ RADIUS CHART

Radius achieved using only the tapered units from a "random bundle" OUTSIDE MEASUREMENT							
Radius (inches)	35"	27"	35"	47"	32"	37"	42"
Unit sequence	9", 12", 15"	9" units only	only 12" units	only 15" units	9", 12" etc.	9", 15" etc.	12", 15" etc.
	uses all units in random bundle	uses all units in small tapered bundle	Note: These sequences will have left over units. Plan to use the left over units in other parts of the project.				

# DURAHOLD®



NATURAL

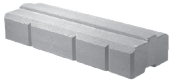

STANDARD  
72" x 12" x 24"  
183cm x 30cm x 60cm  
**SPECIAL ORDER**



CORNER 90°  
60" x 12" x 24"  
152cm x 30cm x 60cm  
**SPECIAL ORDER**



COPING  
72" x 12" x 24"  
183cm x 30cm x 60cm  
**SPECIAL ORDER**



CLOSED END COPING  
72" x 12" x 24"  
183cm x 30cm x 60cm  
**SPECIAL ORDER**

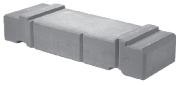

TIE-BACK  
72" x 12" x 24"  
183cm x 30cm x 60cm  
**SPECIAL ORDER**



1/2 COPING  
36" x 12" x 24"  
91.5cm x 30cm x 60cm  
**SPECIAL ORDER**

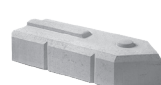

CORNER 45°  
60" x 12" x 24"  
152cm x 30cm x 60cm  
**SPECIAL ORDER**  
(Right Corner Shown)



1/2 STANDARD  
36" x 12" x 24"  
91.5cm x 30cm x 60cm  
**SPECIAL ORDER**



Stones & Bundling	Face Feet Per		Linear Feet Per		Units Per		Per Bundle		Lbs Per	
	Bundle	Unit	Bundle	Unit	Bundle	Face Feet	Layers	Sections	Unit	Bundle
Coping Closed End 72"		6	-	6	1	0.17	-	-	1,560	-
Half Coping	-	3	-	3	1	0.33	1	-	780	780
Corner 45° Right	-	4.91	-	-	1	0.20	1	-	1,480	1,480
Corner 90° Right	-	4.91	-	-	1	0.20	1	-	1,320	1,320
Coping 72"	-	6	-	6	1	0.17	1	-	1,560	1,560
Wall Half	-	3	-	3	1	0.33	1	-	870	870
Wall Standard	-	6	-	6	1	0.17	1	-	1,680	1,680
Wall Tieback	-	6	-	6	1	0.17	1	-	1,660	1,660

Notes: **ALL DURAHOLD IS SPECIAL ORDER ONLY**

\*Closed-end coping units are available and are closed on both ends so that they may be used as left or right. Tie-back units are reinforced with steel. Half (1/2) Standard Units are slightly tapered and can be used to create a 45 foot radius. Refer to terms and conditions for placement rates. All measurements are nominal.

Unilock, (through Risi Stone® Systems International), can provide you with preliminary site engineering for most commercial projects. Soils information, site drawings, and loading requirements are some of the information details required in order to provide you with this engineering. Contact your local representative for details. Retaining wall engineering software is also available free of charge at [www.unilock.com](http://www.unilock.com).

Internal Use Only, DHI ON

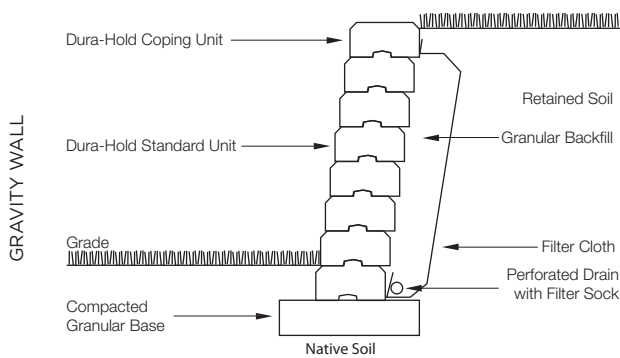

Cross sections are examples, and must not be used for construction.

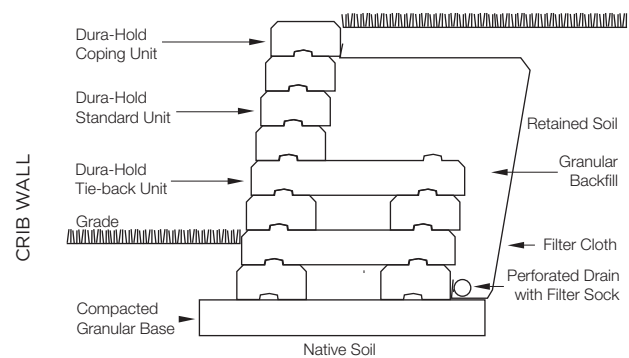

Cross sections are examples, and must not be used for construction.

# DURAHOLD2®



NATURAL

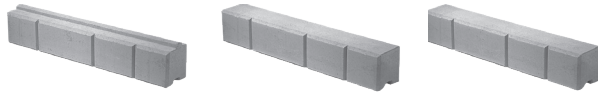

**STANDARD**  
72" x 12" x 14"  
183cm x 30cm x 36cm  
**SPECIAL ORDER**

**COPING**  
72" x 12" x 14"  
183cm x 30cm x 36cm  
**SPECIAL ORDER**

**CLOSED END COPING**  
72" x 12" x 14"  
183cm x 30cm x 36cm  
**SPECIAL ORDER**

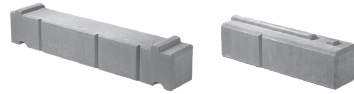

**TIE-BACK**  
72" x 12" x 14"  
183cm x 30cm x 36cm  
**SPECIAL ORDER**

**CORNER 90°**  
36" x 12" x 14"  
90cm x 30cm x 36cm  
(Right Corner Shown)  
**SPECIAL ORDER**



Stones & Bundling	Face Feet Per		Linear Feet Per		Units Per		Per Bundle		Lbs Per	
	Bundle	Unit	Bundle	Unit	Bundle	Face Feet	Layers	Sections	Unit	Bundle
Coping Closed End 72"	6	6	6	6	1	0.17	1	-	884	884
Corner 90° Left	3	3	3	3	1	0.33	1	-	460	460
Coping 72"	6	6	6	6	1	0.17	1	-	884	884
Wall Standard	6	6	6	6	1	0.17	1	-	940	940
Wall Tieback	6	6	6	6	1	0.17	1	-	940	940

Notes: **ALL DURAHOLD2 IS SPECIAL ORDER ONLY**

\*Closed-end Coping units are available and are closed on both ends so that they may be used as lefts or rights. Tie-back units are reinforced with steel. Refer to terms and conditions for placement rates. All measurements are nominal.

For DuraHold® and DuraHold2, Unilock, through Risi Stone® Systems International, can provide preliminary site engineering for most commercial projects. Soils information, site drawings, and loading requirements are some of the information details required in order to provide this preliminary site engineering. Contact your local Unilock representative for details. Retaining wall engineering software is also available free of charge at [www.unilock.com](http://www.unilock.com).

Internal Use Only. DH2 ON

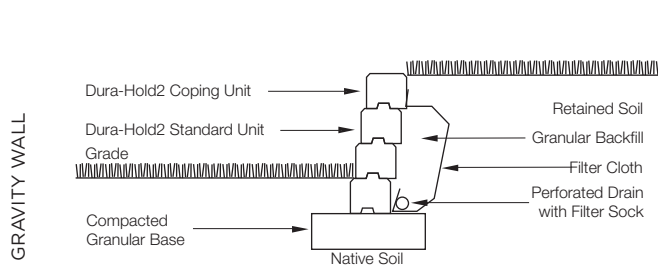

Cross sections are examples, and must not be used for construction.

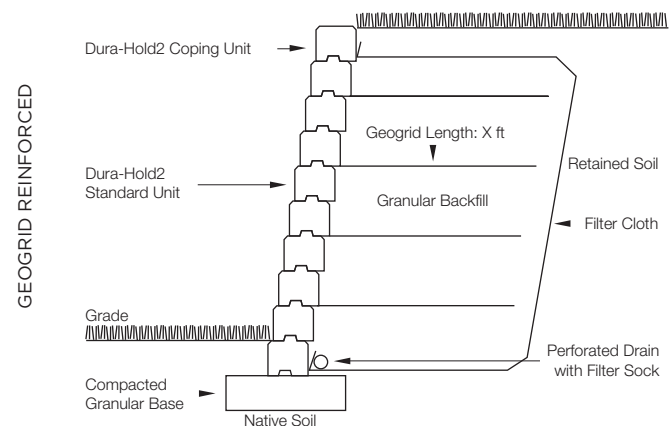

Cross sections are examples, and must not be used for construction.

# ESTATE WALL®



RIVER

SIERRA

GRANITE

**NEW FOR 2019**

New Granite color is available in 6" wall and 6" corner



**LARGE WEDGE**  
14.75" x 6" x 9"  
37.5cm x 15cm x 22.8cm



**MEDIUM WEDGE**  
12" x 6" x 9"  
30cm x 15cm x 22.8cm



**SMALL WEDGE**  
9" x 6" x 9"  
22.8cm x 15cm x 22.8cm

6" Random Bundle  
Individual units cannot be sold separately.



**LARGE WEDGE**  
14.75" x 3" x 9"  
37.5cm x 7.5cm x 22.8cm



**MEDIUM WEDGE**  
12" x 3" x 9"  
30cm x 7.5cm x 22.8cm



**SMALL WEDGE**  
9" x 3" x 9"  
22.8cm x 7.5cm x 22.8cm

3" Random Bundle  
Individual units cannot be sold separately.



**6" CORNER**  
12.5" x 6" x 9"  
31.7cm x 15cm x 22.8cm



**3" CORNER**  
12.5" x 3" x 9"  
31.7cm x 7.5cm x 22.8cm



**LEDGESTONE COPING**  
24" x 12" x 3"  
30.5cm x 61cm X 7.5cm

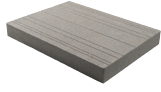

**UNIVERSAL BASE UNIT**  
19" x 14" x 2"  
48.2cm x 35.5cm x 5.5cm

We recommend Unilock's Ledgestone™ (page 35), Brussels Fullnose™ (page 35) or Brussels Double Fullnose™ (page 35) as capping options for this product.

Stones & Bundling	Face Feet Per		Linear Feet Per		Units Per		Per Bundle		Lbs Per	
	Bundle	Unit	Bundle	Unit	Bundle	Face Feet	Layers	Sections	Unit	Bundle
Ledgestone Coping 24"	-	-	24.00	2.000	12	-	-	-	64	772
Universal Base Unit	-	-	95	1.58	60	-	-	-	46.93	2,816
Corner Unit 3"	28.22	0.44	-	-	64	2.27	-	-	33	2,110
Corner Unit 6"	28.22	0.88	-	-	32	1.13	-	-	56	1,776
Std 6"	24.00	-	42.56	-	48	-	-	-	48	2,297
Large Wedge	-	0.61	-	-	-	1.65	-	-	-	-
Medium Wedge	-	0.48	-	-	-	2.06	-	-	-	-
Small Wedge	-	0.37	-	-	-	2.72	-	-	-	-
Wall Multi Unit 3"	24.00	-	85.12	-	96	-	-	-	25	2,408
Large Wedge	-	0.30	-	-	-	3.30	-	-	-	-
Medium Wedge	-	0.24	-	-	-	4.13	-	-	-	-
Small Wedge	-	0.18	-	-	-	5.43	-	-	-	-

Notes: Maximum height for vertical installation - 21" including the stone in the ground (under optimum conditions). Inside radius 45" / outside radius 54". Approximately 16 units of each size are in the 6" bundle and 32 units of each size in the 3" bundle. Wall bundle has approximately 5 end units in each bundle. Ledgestone, Brussels XL, Brussels Fullnose, Brussels Double Fullnose or Stonehenge 12x12 complement as a possible coping. All measurements are nominal.

Internal Use Only. EWL OH

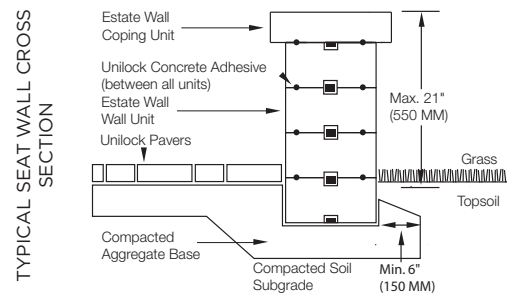
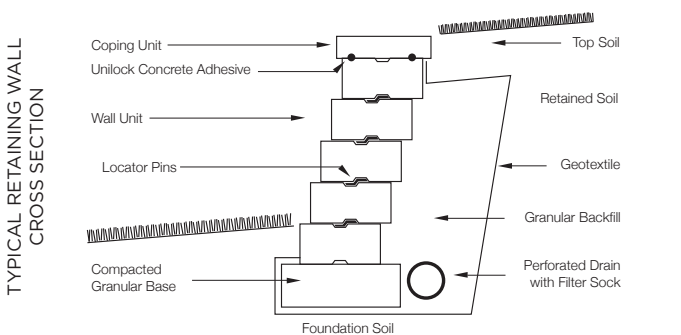

For setback application - Place device perpendicular to channel with round section facing the back of the unit

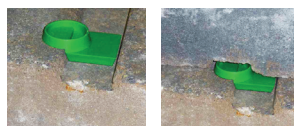

For vertical application - Place device parallel to channel



# LINEO DIMENSIONAL STONE®



PLATINUM



SIERRA



WALNUT



PILLAR / CORNER UNIT  
16" X 4" X 8"  
40CM X 10CM X 20CM



LINEO PILLAR CAP  
29" X 29" X 4"  
74CM X 74CM X 10CM  
(Buff & Grey)

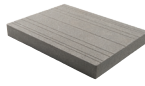

UNIVERSAL BASE UNIT  
19" X 14" X 2"  
48.2CM X 35.5CM X 5.5CM



XL RECTANGLE  
24" x 4" x 8"  
60cm x 10cm x 20cm



LARGE RECTANGLE  
20" x 4" x 8"  
50cm x 10cm x 20cm



RECTANGLE  
16" x 4" x 8"  
40cm x 10cm x 20cm



SMALL RECTANGLE  
12" x 4" x 8"  
30cm x 10cm x 20cm

Random Bundle  
Individual units cannot  
be sold separately

Stones & Bundling	Face Feet Per		Linear Feet Per		Units Per		Per Bundle		Lbs Per	
	Bundle	Unit	Bundle	Unit	Bundle	Face Feet	Layers	Sections	Unit	Bundle
Pillar Unit	47.81	0.66	96.00	1.33	72	1.51			39	2,808
Pillar Cap (29 x 29)	-	-	-	-	5	-	-	-	302	1,510
Universal Base Unit	-	-	95	1.58	60	-	-	-	46.93	2,816
Random Wall Bundle:	30.00	0.50	90.00	1.50	60	-	-	-	44	2,642
Large Rectangle	-	-	-	-	15	1.80	-	-	-	-
Rectangle	-	-	-	-	15	2.25	-	-	-	-
Small Rectangle	-	-	-	-	15	3.00	-	-	-	-
XL Rectangle	-	-	-	-	15	1.50	-	-	-	-

Notes: Sold in full bundle quantities only. Pillar cap sold individually, not full bundle. All measurements are nominal.

Internal Use Only. LDS CH

# PISA2®



GRANITE



RIVER



SANDSTONE



SIERRA



12" COPING  
12" x 3" x 12"  
30cm x 7.5cm x 30cm

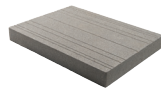

UNIVERSAL BASE UNIT  
19" x 14" x 2"  
48.2cm x 35.5cm x 5.5cm



STANDARD  
8" x 6" x 12"  
20cm x 15cm x 30cm



TAPERED  
8" x 6" x 12"  
20cm x 15cm x 30cm



XL TAPERED  
16" x 6" x 12"  
40cm x 15cm x 30cm



CORNER  
12" x 6" x 8"  
30cm x 15cm x 20cm

Stones & Bundling	Face Feet Per		Linear Feet Per		Units Per		Per Bundle		Lbs Per	
	Bundle	Unit	Bundle	Unit	Bundle	Face Feet	Layers	Sections	Unit	Bundle
Corner Unit	15.00	0.833	-	-	18	1.20	-	3	52.41	943
Wall Standard	20.00	0.333	40.00	0.667	60	3.00	-	2	42.83	2,570
Wall Xtra Tapered	20.00	0.333	40.00	0.667	60	3.00	-	2	38.42	2,305
Wall XL	21.33	0.667	42.67	1.333	32	1.50	-	-	77.09	2,467
Universal Base Unit	-	-	95	1.58	60	-	-	-	46.93	2,816
12" Coping	21.00	0.250	84.00	1.000	84	4.00	-	2	32.31	2,714

Notes: Maximum height - 48" (under optimum conditions). Higher walls can be achieved using geogrid reinforcement. Tapered units will allow for a minimum 5ft. outside radius. XL Tapered units allow for an 8ft. outside radius. \*\*12" Coping bundle has 7 double units of Closed-End coping. All measurements are nominal.

Unilock, through Risi Stone® Systems International, can provide preliminary site engineering for most commercial projects. Soils information, site drawings, and loading requirements are some of the information details required in order to provide this preliminary site engineering. Contact your local Unilock representative for details. Retaining wall engineering software is also available free of charge at [www.unilock.com](http://www.unilock.com).

Internal Use Only. PS2 OH

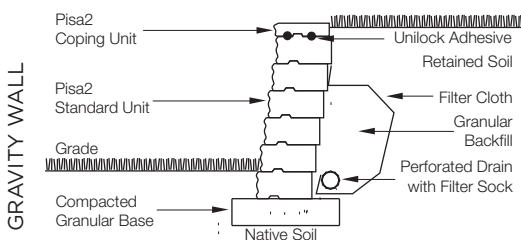

Cross sections are examples, and must not be used for construction.

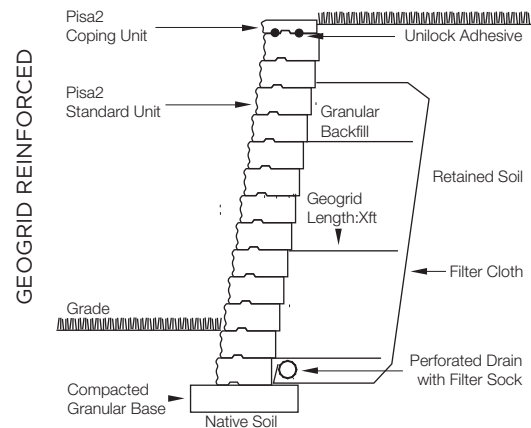

Cross sections are examples, and must not be used for construction.

# RIVERCREST® WALL



COASTAL SLATE

BUFF

## TECHNICAL ADVANTAGES

### Reala™ Surface Technology

Ultra-realistic textures cast from natural stone, brick and historic cobblestones.



**LONG CORNER UNIT**  
18" x 9-10" x 2 1/4"  
45cm x 23-25cm x 6cm

**SHORT CORNER UNIT**  
15" x 9-10" x 2 1/4"  
37.5cm x 23-25cm x 6cm

Random Bundle  
Individual units cannot be sold separately



**JUMPER CORNER UNIT**  
12" x 9-10" x 4 1/2"  
31cm x 23-25cm x 11.4cm

**STANDARD UNIT 1**  
8" x 9-10" x 2 1/4"  
20cm x 23-25cm x 6cm

**STANDARD UNIT 2**  
12" x 9-10" x 2 1/4"  
31cm x 23-25cm x 6cm

**STANDARD UNIT 3**  
12" x 9-10" x 2 1/4"  
31cm x 23-25cm x 6cm

**STANDARD UNIT 4**  
17" x 9-10" x 2 1/4"  
42.5cm x 23-25cm x 6cm

Random Bundle  
Individual units cannot be sold separately

**JUMPER UNIT 1**  
8" x 9-10" x 4 1/2"  
20cm x 23-25cm x 11.4cm

**JUMPER UNIT 2**  
12" x 9-10" x 4 1/2"  
31cm x 23-25cm x 11.4cm

**JUMPER UNIT 3**  
12" x 9-10" x 4 1/2"  
31cm x 23-25cm x 11.4cm

**JUMPER UNIT 4**  
17" x 9-10" x 4 1/2"  
42.5cm x 23-25cm x 11.4cm

Jumper Bundle  
Individual units cannot be sold separately

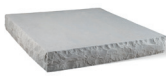

**LEDGESTONE PILLAR CAP**  
24" x 24" x 4"  
61cm x 61cm X 10cm

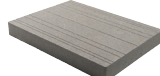

**UNIVERSAL BASE UNIT**  
19" x 14" x 2"  
48.2cm x 35.5cm x 5.5cm

## RAPID PILLAR SYSTEM



**PILLAR UNIT**  
20" x 20" x 4 1/2"  
50cm x 50cm x 11.4cm



**RIVERCREST FIRE PIT KIT**



Stones & Bundling	Face Feet Per		Linear Feet Per		Units Per		Per Bundle		Lbs Per	
	Bundle	Unit	Bundle	Unit	Bundle	Face Feet	Layers	Sections	Unit	Bundle
Wall Standard	24.30	-	132.8	-	128	-	8	-	15	1,902
Standard Unit 1	3.93	0.123	21.33	0.656	32	8.15	-	-	-	-
Standard Unit 2	6.09	0.190	33.07	1.017	32	5.26	-	-	-	-
Standard Unit 3	6.09	0.190	33.07	1.017	32	5.26	-	-	-	-
Standard Unit 4	8.34	0.256	45.33	1.394	32	3.84	-	-	-	-
Jumper	24.30	-	66.40	-	64	-	4	-	39	2,495
Jumper Unit 1	3.93	0.245	10.67	0.656	16	4.07	-	-	-	-
Jumper Unit 2	6.09	0.380	16.53	1.017	16	2.63	-	-	-	-
Jumper Unit 3	6.09	0.380	16.27	1.017	16	2.63	-	-	-	-
Jumper Unit 4	8.34	0.513	22.67	1.394	16	1.92	-	-	-	-
Corner Unit Bundle:	16.21	-	55.381	-	40	-	4	-	29.33	1,173
Long Corner Unit	-	0.426	-	1.499	20	-	-	-	-	-
Short Corner Unit	-	0.385	-	1.270	20	-	-	-	-	-
Pillar 20" x 20"	-	-	-	-	8	-	4	-	116.75	934
Corner Jumper Unit	21.60	0.675	57.73	1.79	32	1.48	-	-	40	1,280
Ledge Stone Pillar Cap	-	-	-	-	8	-	-	-	302	1,510
Universal Base Unit	-	-	95	1.58	60	-	-	-	46.93	2,816

Notes: **Sold in full bundles only.** Rivercrest is recommended for walls under 2ft. Ideal for straight or curved walls, seat walls, pillars, tree rings, planters, firepits and grill islands. Integrated connectors require no pins or clips. Minimum radius using equal amounts of each unit is 1.25m / 4.1ft. Using only unit 1 & 3 a 1.055m / 3.5ft radius can be achieved. For more information, please consult the Rivercrest installation booklet.

Unilock, through Risi Stone® Systems International, can provide preliminary site engineering for most commercial projects. Soils information, site drawings, and loading requirements are some of the information details required in order to provide this preliminary site engineering. Contact your local Unilock representative for details. Retaining wall engineering software is also available free of charge at [www.unilock.com](http://www.unilock.com).

Internal Use Only. RVC ON

# ROMANPISA®



GRANITE

RIVER

SIERRA

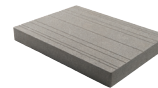

STANDARD  
8" x 6" x 12"  
20cm x 15cm x 30cm

TAPERED  
8" x 6" x 12"  
20cm x 15cm x 30cm

CORNER  
12" x 6" x 8"  
30cm x 15cm x 20cm

ROMAN COPING  
12" x 3" x 12"  
30cm x 7.5cm x 30cm

UNIVERSAL BASE UNIT  
19" x 14" x 2"  
48.2cm x 35.5cm x 5.5cm

Stones & Bundling	Face Feet Per		Linear Feet Per		Units Per		Per Bundle		Lbs Per	
	Bundle	Unit	Bundle	Unit	Bundle	Face Feet	Layers	Sections	Unit	Bundle
Coping 12"	21.00	0.250	84.00	1.000	84	4.00	-	2	32.21	2,705
Corner Unit	20.00	0.833	-	-	24	1.20	-	2	42.83	1,028
Wall Standard	20.00	0.333	40.00	0.667	60	3.00	-	2	42.83	2,570
Wall Xtra Tapered	20.00	0.333	40.00	0.667	60	3.00	-	2	37.52	2,251
Universal Base Unit	-	-	95	1.58	60	-	-	-	46.93	2,816

Notes: Maximum height – 48" (under optimum conditions). Higher walls can be achieved using geogrid reinforcement. All measurements are nominal. Corners are sold as double units (one left and one right). \*\*On average, each bundle contains 7 closed-end coping units. Unilock, through Risi Stone® Systems International, can provide preliminary site engineering for most commercial projects. Soils information, site drawings, and loading requirements are some of the information details required in order to provide this preliminary site engineering. Contact your local Unilock representative for details. Retaining wall engineering software is also available free of charge at [www.unilock.com](http://www.unilock.com). All measurements are nominal.

Internal Use Only. RPA OH

# ROMANSTACK®



GRANITE

RIVER

SIERRA



WEDGE UNIT  
8" x 4" x 8"  
20cm x 10cm x 20cm

Stones & Bundling	Face Feet Per		Linear Feet Per		Units Per		Per Bundle		Lbs Per	
	Bundle	Unit	Bundle	Unit	Bundle	Face Feet	Layers	Sections	Unit	Bundle
Coping	31.68	0.220	94.49	0.656	144	4.55	6	-	16.37	2,357

Notes: Maximum height – 20" (under optimum conditions) including materials below grade. Radius - minimum outside radius 29.5". All measurements are nominal.

Internal Use Only. RST OH



# SIENASTONE®



GRANITE\*\*



NATURAL



NEVADA\*\*



STANDARD 925  
39" x 7¼" x 36½"  
100cm x 18.5cm  
x 92.5cm  
**SPECIAL ORDER**



STANDARD 500  
39" x 7¼" x 20"  
100cm x 18.5cm  
x 50cm



STANDARD 333  
39" x 7¼" x 13½"  
100cm x 18.5cm  
x 33cm  
**SPECIAL ORDER**



CORNER 90° (left & right)  
36½" x 7¼" x 20"  
92.5cm x 18.5cm x 50cm  
**SPECIAL ORDER**



COPING  
39" x 7¼" x 20"  
100cm x 18.5cm x 50cm



CLOSED-END COPING \*\*  
48" x 7¼" x 20"  
120cm x 18.5cm x 50cm  
ALL COLORS



Stones & Bundling	Face Feet Per		Linear Feet Per		Units Per		Per Bundle		Lbs Per	
	Bundle	Unit	Bundle	Unit	Bundle	Face Feet	Layers	Sections	Unit	Bundle
Coping Closed End 48"	14.50	2.42	24	4	6	0.41	-	3	570	3,420
Coping 39"	12.00	2	19.5	3.25	6	0.50	-	3	463.33	2,780
Corner 90°	17.20	2.87	-	-	6	0.35	-	3	477	2,862
Wall 333	18.00	2.00	-	-	9	0.50	-	3	318	2,862
Wall 500 - 39"	12.00	2.00	19.50	3.25	6	0.50	-	3	477	2,862
Wall 925 - 39"	6.00	2.00	9.75	3.25	3	0.50	-	3	954	2,862

\*\*48" Closed-End Copping Only: Granite, Natural, Nevada

Notes: Only 48" Closed-end Copping units are available in color. Copping units can be used to construct steps. Custom color available (minimums apply). Unilock, through Risi Stone® Systems International, can provide preliminary site engineering for most commercial projects. Soils information, site drawings, and loading requirements are some of the information details required in order to provide this preliminary site engineering. Contact your local Unilock representative for details. Retaining wall engineering software is also available free of charge at [www.unilock.com](http://www.unilock.com).

Internal Use Only. SST OH, SST\_CECoping ON

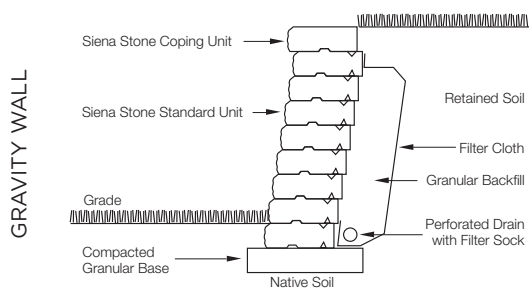

Cross sections are examples, and must not be used for construction.

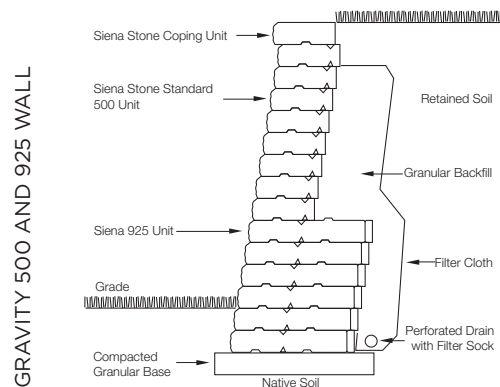

Cross sections are examples, and must not be used for construction.

# SPLIT'N STACK®



GRANITE

RIVER

SIERRA



WEDGE UNIT  
8" x 4" x 8"  
20cm x 10cm x 20cm

Stones & Bundling	Face Feet Per		Linear Feet Per		Units Per		Per Bundle		Lbs Per	
	Bundle	Unit	Bundle	Unit	Bundle	Face Feet	Layers	Sections	Unit	Bundle
Coping	29.00	0.193	87.50	0.583	150	5.17	-	-	17	2,611

Notes: Maximum height - 20" (under optimum conditions) including material below grade. Radius - minimum outside radius 29". All measurements are nominal.

Internal Use Only. SPL OH

## DETAILS FOR ROMANSTACK® & SPLIT'N STACK®

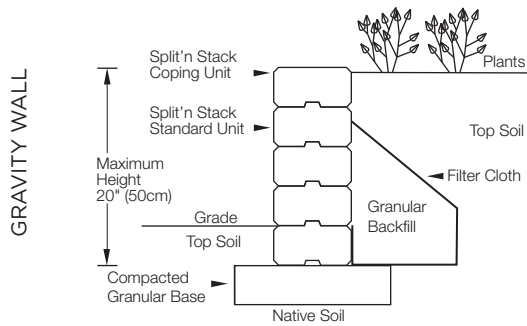

Cross sections are examples, and must not be used for construction.

TYPICAL RADIUS  
Minimum outside radius 29"

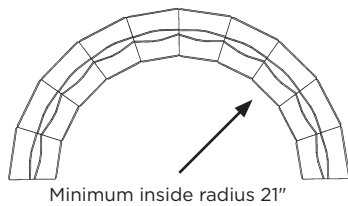

Height Courses Length of Wall Measured in Feet

Height	Courses	Length of Wall Measured in Feet					
		5'	10'	15'	20'	25'	30'
4"	1	9	18	27	36	45	54
8"	2	18	36	54	72	90	108
12"	3	27	54	81	108	135	162
16"	4	36	72	108	144	180	216
20"	5	45	90	135	180	225	270

CIRCLE CHART

FT	Full Circle # of Units	Half Circle # of Units	Quarter Circle # of Units
2.5	23	12	7
3	28	15	8
4	38	20	10
OUTSIDE RADIUS	5	47	24
	6	56	29
	7	66	34
	8	75	38
	9	84	43
	10	94	48



**LOOK INSIDE!**  
U-Cara fascia panels hang easily on the patented Sure Track™ backer block.



U-Cara™ Fascia panels can be placed anywhere along the Sure Track Backer Block, allowing for a variety of patterns, color and texture combinations not possible with other systems.

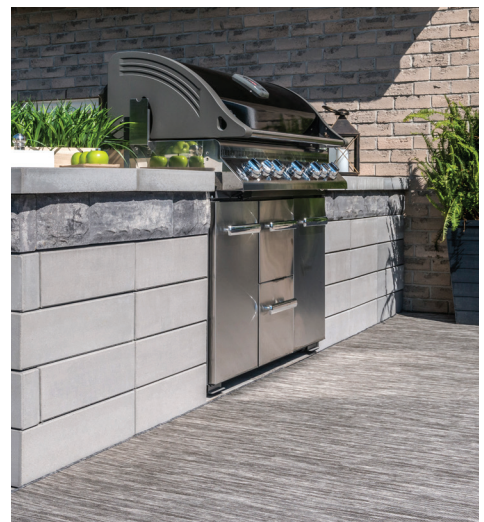
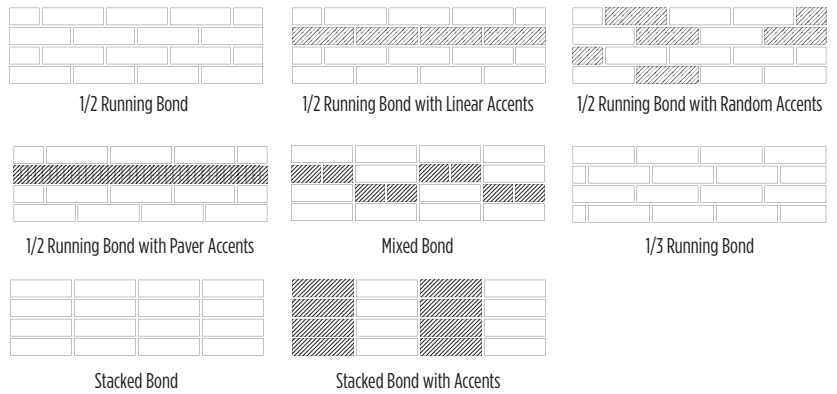

The U-Cara Multi-Face Wall System represents a revolution in wall design.

This patented system, exclusive to Unilock®, is comprised of two basic components:

- | Sure Track™ backer blocks provide dimensionally accurate structure
- | U-Cara fascia panels provide unlimited design options



FRENCH GREY  
UMBRIANO® FINISH



WINTER MARVEL  
UMBRIANO FINISH



MIDNIGHT SKY  
UMBRIANO FINISH



SUMMER WHEAT  
UMBRIANO FINISH



RIVER  
PITCHED FACE



SIERRA  
PITCHED FACE



STEEL GREY  
PITCHED FACE



CREAM  
SMOOTH FACE



GRAPHITE  
SMOOTH FACE



OPAL  
SMOOTH FACE



SURE TRACK  
STANDARD BACKER  
6" x 8" x 6"  
15cm x 20cm x 15cm



SURE TRACK  
LARGE BACKER  
6" x 7" x 12"  
15cm x 17.5cm x 30cm



UNIVERSAL BASE UNIT  
19" x 14" x 2"  
48.2cm x 35.5cm x 5.5cm



SURE TRACK  
CORNER INSERT  
L = 2" / 5cm



STANDARD FASCIA  
HALF PANEL  
6" x 9¼" x 2¾"  
15cm x 23.3cm x 6cm  
**UMBRIANO, PITCHED & SMOOTH**



CLOSED-END FASCIA  
PANEL  
6" x 21" x 2¾"  
15cm x 53cm x 6cm  
**UMBRIANO, PITCHED & SMOOTH**



STANDARD FASCIA  
PANEL  
6" x 18½" x 2¾"  
15cm x 46.6cm x 6cm  
**UMBRIANO, PITCHED & SMOOTH**



UNIVERSAL  
COPING  
19" x 14" x 2¾"  
48.2cm x 35.5cm x 7cm

CORNER BUNDLE

Stones & Bundling	Face Feet Per		Linear Feet Per		Units Per		Per Bundle		Lbs Per	
	Bundle	Unit	Bundle	Unit	Bundle	Face Feet	Layers	Sections	Unit	Bundle
Sure Track Standard Backer	33.91	0.323	-	-	105	3	-	-	23.208	2,320
Sure Track Large Backer	15.82	0.283	-	-	56	-	-	-	35.924	1,992
Standard Fascia Panel (Smooth)	61.52	0.732	-	-	84	6	-	-	18.015	1,598
Standard Fascia Panel (Pitched)	61.52	0.732	-	-	84	-	-	-	20.779	1,809
Corner Bundle (Smooth)	54.20	-	-	-	84	-	-	-	-	1,648
Closed-End Fascia Panel	38.94	0.833	-	-	42	-	-	-	20.595	1,297.5
Half Fascia Panel	15.25	0.363	-	-	42	9	-	-	8.932	562.7
Corner Bundle (Pitched)	54.2	-	-	-	84	-	-	-	-	1,415.1
Closed-End Fascia Panel	38.94	0.833	-	-	42	6	-	-	23.621	992.1
Half Fascia Panel	15.25	0.363	-	-	42	-	-	-	10.073	423.1
Universal Coping Bundle	-	-	56.93	1.58	36	8	-	-	58.83	2,118
Universal Base Unit	-	-	95	1.58	60	-	-	-	46.93	2,816

Notes: Sold in full bundles only. Product is shipped on skids. All measurements are nominal.

Internal Use Only. UCA OH

# BRUSSELS FULLNOSE™ & BRUSSELS DOUBLE FULLNOSE™ (CLASSIC & ANTIQUED)



COFFEE CREEK  
**WHILE QUANTITIES  
LAST**



LIMESTONE



SANDSTONE



SIERRA



MOCHA \*

\* Mocha is not available in Double Fullnose



CHARCOAL \*\*

\*\* Charcoal is not available in Antique Finish

CLASSIC FINISH

ANTIQUED FINISH



STANDARD  
6" x 12" x 2 3/4"  
15cm x 30cm x 7cm



DOUBLE  
6" x 12" x 2 3/4"  
15cm x 30cm x 7cm



STANDARD  
6" x 12" x 2 3/4"  
15cm x 30cm x 7cm



DOUBLE  
6" x 12" x 2 3/4"  
15cm x 30cm x 7cm

Stones & Bundling	Unit	SqFt Per				Per Bundle		Soldier LnFt Per			Sailor LnFt per			Units Per			Lbs Per		
	Thickness	Bundle	Layer	Section	Stone	Layers	Sections	SqFt	Section	Bundle	SqFt	Section	Bundle	SqFt	Section	Bundle	Layer	Section	Bundle
Double Face	2 3/4" (7cm)	78.28	-	19.57	0.489	-	4	0.978	20.0	80.0	-	-	-	2.04	40	160	-	594	2,376
Standard	2 3/4" (7cm)	78.28	-	19.57	0.489	-	4	0.978	20.0	80.0	-	-	-	2.04	40	160	-	594	2,376

Internal Use Only. BFN OH

# LEDGESTONE™ PILLAR CAP, COPING, & FULLNOSE



BUFF

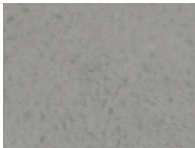

GREY

## PRODUCT TECHNOLOGY

### Reala™ Surface Technology

Ultra-realistic textures cast from natural stone, brick and historic cobblestones.

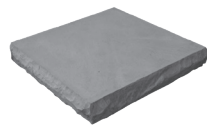

24" PILLAR CAP  
24 x 24 x 4"  
61 x 61 x 10cm

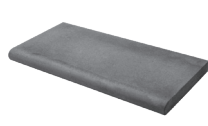

FULLNOSE COPING  
12 x 24 x 2 3/8"  
30.5 x 61 x 6cm  
**NEW SIZE**



CLOSED-END COPING  
12 x 24 x 2 3/4"  
30.5 x 61 x 7cm



LARGE CLOSED-END COPING  
**NEW FOR 2019**  
13.5" x 30" x 2 3/4"  
61 x 122 x 7cm

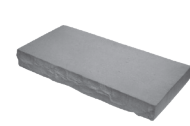

COPING UNIT  
12 x 24 x 2 3/4"  
30.5 x 61 x 7cm

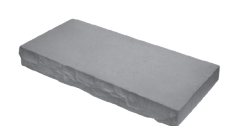

LARGE COPING UNIT  
**NEW FOR 2019**  
13.5" x 30" x 2 3/4"  
61 x 122 x 7cm

Stones & Bundling	Face Feet Per		Linear Feet Per		Units Per		Per Bundle		Lbs Per	
	Bundle	Unit	Bundle	Unit	Bundle	Face Feet	Layers	Sections	Unit	Bundle
Pillar Cap 24" x 24"	-	-	10.00	2.000	5	-	-	-	159	795
Coping Closed End 24"	-	-	24.00	2.000	12	-	-	-	66	796
Coping 24"	-	-	24.00	2.000	12	-	-	-	64	772
Fullnose Coping 24"	-	-	26.00	2.000	13	-	-	-	55.62	723
Large Closed-End Coping	-	-	30	2.50	12	-	-	-	93	1,116
Large Coping	-	-	30	2.50	12	-	-	-	94	1,128

Notes: 4 LedgeStone end coping units can be used to cap pillars larger than 20". That leaves a small opening for lighting. All caps require a skid that is refundable upon return in good condition. All measurements are nominal.

Internal Use Only. LDG CH

# LEDGESTONE™ STEPS

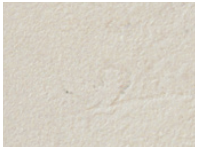

BUFF



GREY

### PRODUCT TECHNOLOGY

#### Reala™ Surface Technology

Ultra-realistic textures cast from natural stone, brick and historic cobblestones.



36" LEDGESTONE STEP  
36" x 18" x 6"  
91.5cm x 46cm x 15cm



48" LEDGESTONE STEP  
48" x 24" x 6"  
122cm x 61cm x 15cm



72" LEDGESTONE STEP  
72" x 24" x 6"  
183cm x 61cm x 15cm

Stones & Bundling	Face Feet Per		Linear Feet Per		Units Per		Per Bundle		Lbs Per	
	Bundle	Unit	Bundle	Unit	Bundle	Face Feet	Layers	Sections	Unit	Bundle
Step - 36" x 18"	-	-	9.00	3.000	3	-	-	-	340	1,021
Step - 48" x 24"	-	-	12.00	4.000	3	-	-	-	609	1,828
Step - 72" x 24"	-	-	18.00	6.000	3	-	-	-	909	2,728

Notes: Steps are rock faced on three sides and all product is sold by the unit. Ledgestone Steps are only available in Buff & Grey.

Internal Use Only. LDG CH

# UNIVERSAL COPING



CREAM



OPAL



GRAPHITE



UNIVERSAL COPING  
19" x 14" x 2¾"  
48.2cm x 35.5cm x 7cm



Stones & Bundling	Face Feet Per		Linear Feet Per		Units Per		Per Bundle		Lbs Per	
	Bundle	Unit	Bundle	Unit	Bundle	Face Feet	Layers	Sections	Unit	Bundle
Universal Coping	-	-	56.93	1.58	36	-	6	-	58.83	2118

Notes: Sold in full bundles only.

Internal Use Only. UNI OH

# LAYING PATTERNS

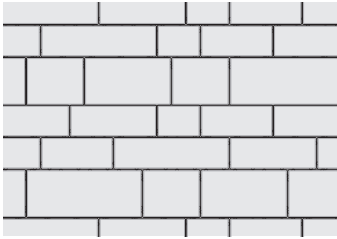

**ARTLINE™ RANDOM** - 100% Random Bundle

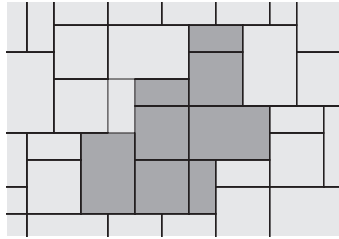

**BEACON HILL™ RANDOM A** - 40% Large Rectangle, 40% Square, 20% Small Rectangle

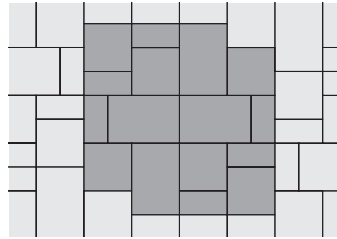

**BEACON HILL™ RANDOM B** - 40% Large Rectangle, 40% Square, 20% Small Rectangle

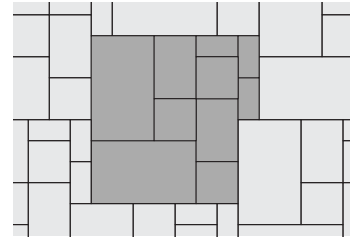

**BEACON HILL™ G** - 50% Random Bundle, 50% XL Unit

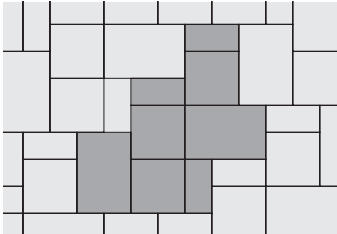

**BRISTOL VALLEY™ RANDOM A** - 40% Large Rectangle, 20% Small Rectangle, 40% Square

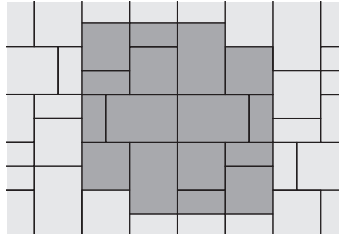

**BRISTOL VALLEY™ RANDOM B** - 40% Large Rectangle, 20% Small Rectangle, 40% Square

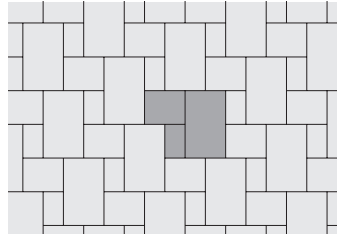

**BRUSSELS BLOCK™ Y** - 57% XL, 29% Standard, 14% Half

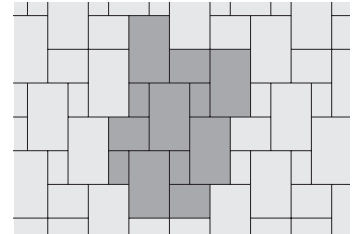

**BRUSSELS BLOCK™ Z** - 67% XL, 20% Standard, 13% Half

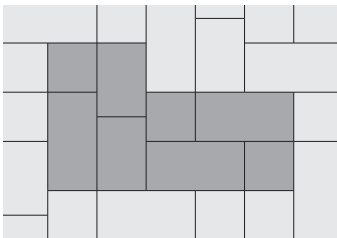

**BOULEVARD A** - 50% Large Rectangle, 25% Medium Rectangle, 25% Square

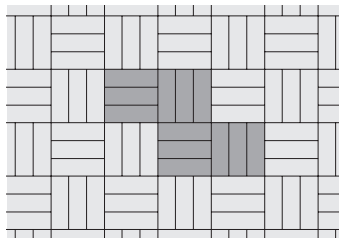

**COPTHORNE™ A** - 100% Standard

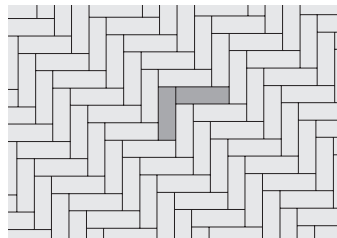

**COPTHORNE™ A** - 100% Standard

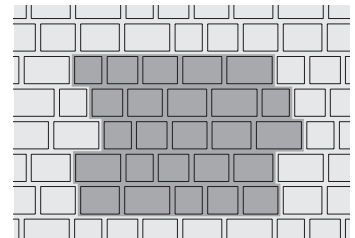

**COURTSTONE** - 100% Random Bundle

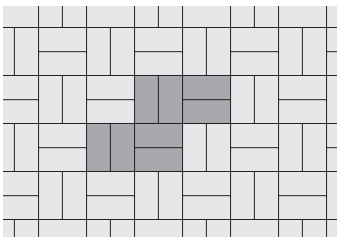

**HOLLANDSTONE/HOLLAND PREMIER D** - 100% Standard

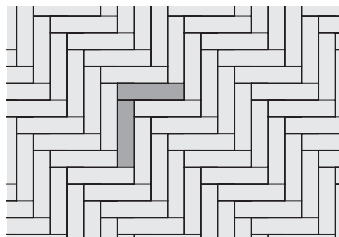

**MATTONI™ A** - 100% Standard

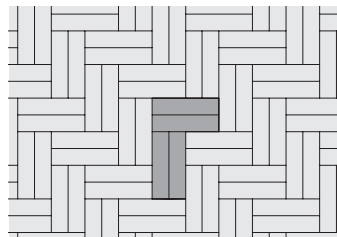

**MATTONI™ B** - 100% Standard

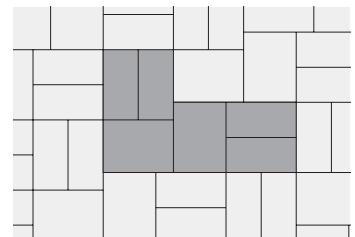

**NATURAL STONE D** - 43% 18 x 24", 57% 12 x 24"

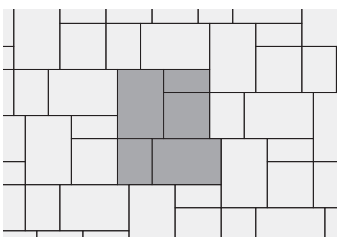

**NATURAL STONE E** - 57% 24 x 36", 19% 24 x 24", 14% 18 x 24", 10% 12 x 24"

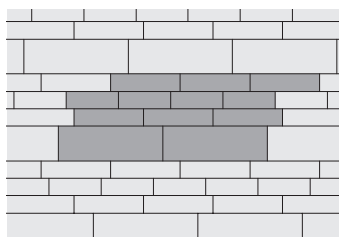

**PROMENADE PLANK PAVER G** - 20% 4 x 12", 40% 4 x 16", 8% 8 x 24"

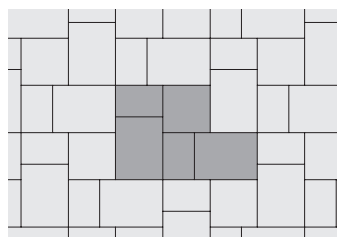

**RICHCLIFF™ A** - 53% 12 x 9", 20% 9 x 9", 27% 6 x 9"

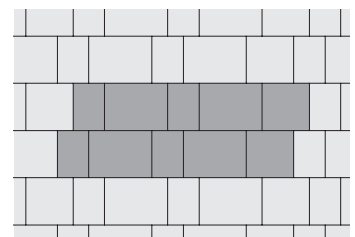

**RICHCLIFF™ B** - 53% 12 x 9", 20% 9 x 9", 27% 6 x 9"

# LAYING PATTERNS

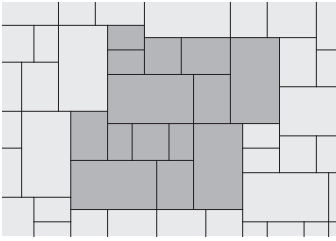

**RICHCLIFF E** - 45% Random Bundle, 55% Large Rectangle

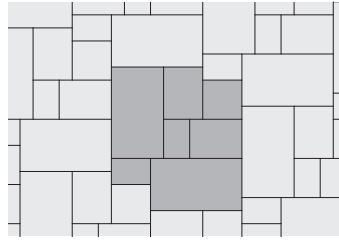

**RICHCLIFF F** - 45% Random Bundle, 55% Large Rectangle

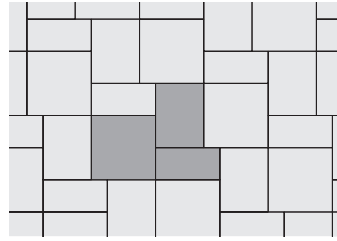

**RIVENSTONE A** - 45% 24 x 24", 33% 18 x 24", 22% 12 x 24"

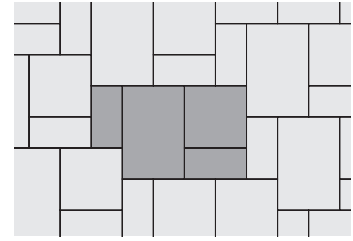

**TREO A** - 100% Random Bundle

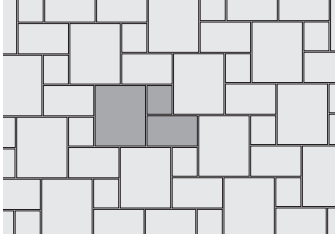

**THORBURY A** - 49% Large Rectangle, 34% Medium Rectangle, 17% Small Rectangle

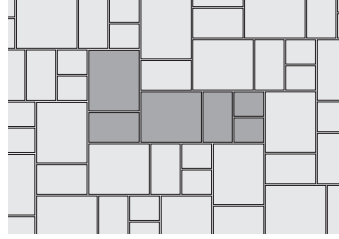

**THORBURY C** - 49% Large Rectangle, 34% Medium Rectangle, 17% Small Rectangle

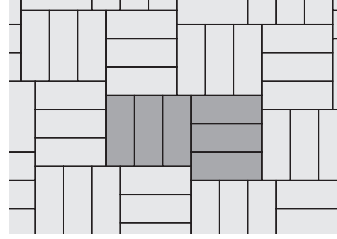

**TOWN HALL A** - 100% Standard

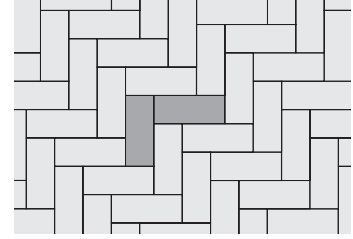

**TOWN HALL B** - 100% Standard

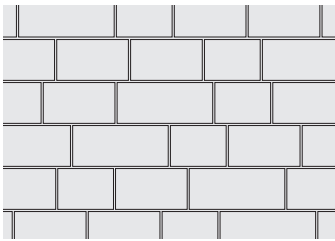

**TRIBECA COBBLE** - 100% Random Bundle

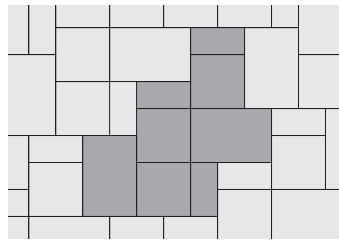

**UMBRIANO RANDOM A** - 40% Large Rectangle, 40% Square, 20% Small Rectangle

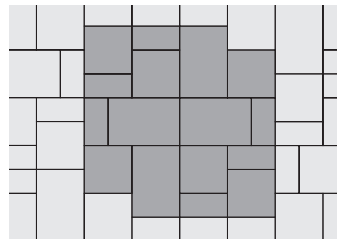

**UMBRIANO RANDOM B** - 40% Large Rectangle, 40% Square, 20% Small Rectangle



# UNILOCK ELEMENTS

## TUSCANY

Large decorative accents adorn the top of the Tuscany fireplace. Brussels Block® Fullnose is used to construct the ledges and mantle of the fireplace.



Tuscany Sierra with Copthorne® \*\*



Tuscany Sandstone with Copthorne® \*\*  
**SPECIAL ORDER**



Barcelona River with Richcliff® \*\*  
**SPECIAL ORDER**

## BARCELONA SPECIAL ORDER

Wide elegant archways and accents over the fireplace and wood boxes constructed. Mantles and ledges in the Barcelona series are made of Ledgestone™.



**MODA**  
**SPECIAL ORDER**

The Moda pre-built fireplace is constructed from Lineo Dimensional Stone and Series™ accent.



**BELLA**  
**SPECIAL ORDER**

The Bella pre-built fireplace is constructed from Rivercrest® Wall.



**BELLA GRILL**  
**SPECIAL ORDER**

The Bella grill is constructed from Rivercrest® Wall.

## TUSCANY FIREPLACE

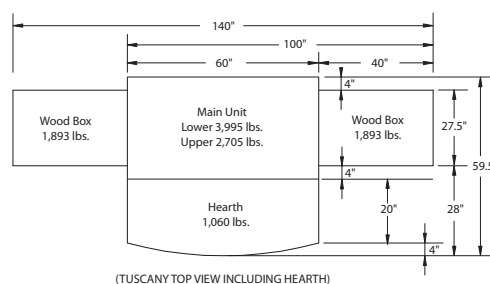
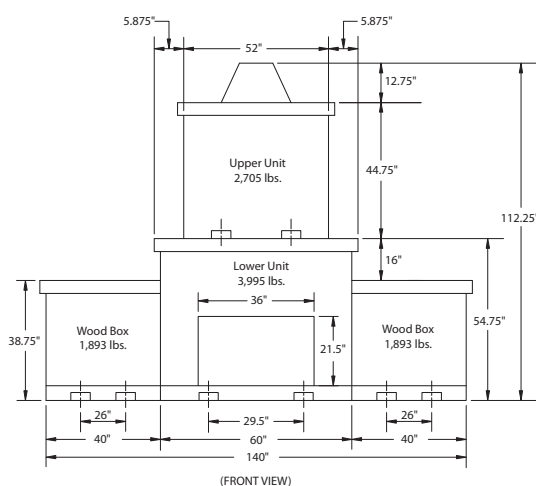

\*\*Units and measurements may not be exactly as shown.

## CUSTOM ACCENTS



Copthorne®



Courtstone®



Richcliff®



Umbriano®

## UNILOCK ELEMENTS (Continued)

Unilock Elements are available in TUSCANY and BARCELONA SERIES



**HEARTH**  
Hearth with gentle curved front.  
1025 lbs



**WOOD BOXES**  
Sold as a set of two and flank either side of the gas or standard fireplace.  
3750 lbs per set



**FIREPLACE**  
Two piece set (base and chimney), and it comes with stainless fire box.  
5620 lbs



**GRILL ISLAND**  
Available with OCS Grill, protective cover, and stainless double door insert.  
3800 lbs



**BRICK OVEN**  
Two piece set (wood box base, brick oven), and it comes with metal termination cap, pipe and cooking utensils.

## TUSCANY & BARCELONA PIZZA OVEN

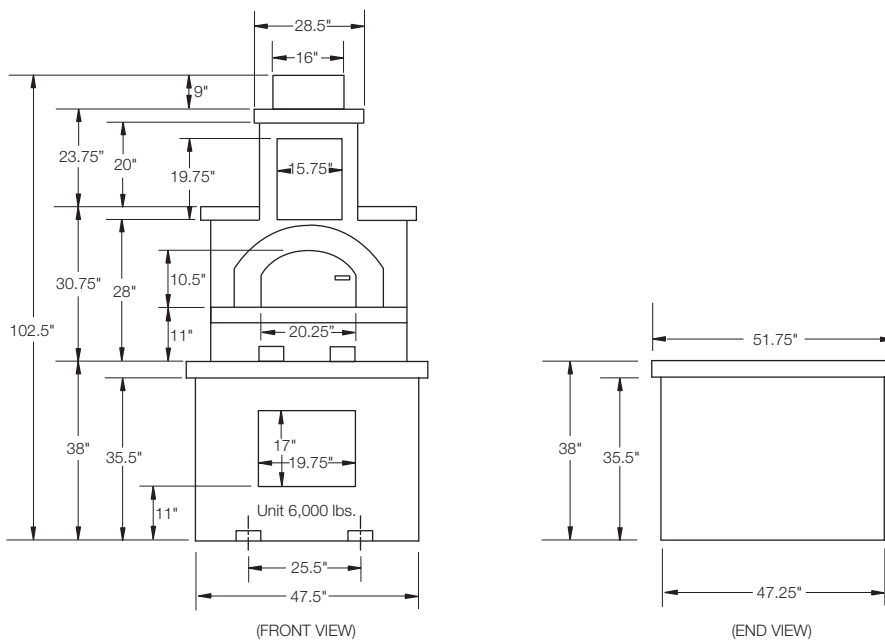

\*\*Units and measurements may not be exactly as shown.

**Guarantee:** The standard Unilock guarantee applies to the units used to construct Unilock Elements. (See Unilock literature for details.) Third party grills and fireboxes carry their respective manufacturer's warranty and may change without notice.

**Note:** Unilock reserves the right to change model designs, accessories and colors without notice. Unilock will not be responsible for improper use or handling that results in property damage. Some models may not be exactly as shown. Fireplaces come complete with UL- approved stainless steel fireboxes. Check local building codes and regulations prior to ordering and installing Unilock Elements.

# RIVERCREST® FIRE PIT

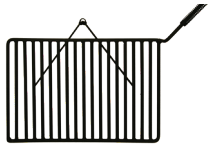

**FIRE PIT GRILL**  
Firepit grill is included and fits securely into the firepit.



COASTAL SLATE



BUFF

# SUNSET FIRE PITS

Round and Square Fire Pits are available in Brussels Dimensional System™ colors: Coffee Creek, Limestone, River, Sandstone and Sierra.



Round



Square

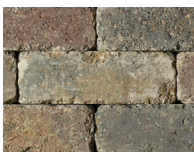
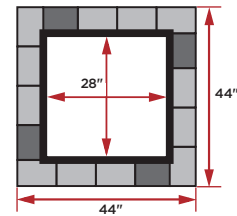
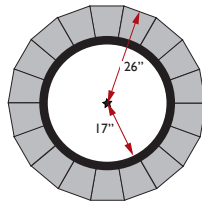

COFFEE CREEK



LIMESTONE



RIVER



SANDSTONE



SIERRA

Stones & Bundling	Stones per Course	Stones per Pallet	Diameter Outside of Stone	Diameter Inside of Stone	Diameter Pit Insert	Lbs/Pallet	Kits/Bundle
Sunset - Pickering Manufacturing/Rivercrest - Georgetown Manufacturing							
Sunset/Brussels Dimensional Stone							
Round Fire Pit	18	54	52"	34"	34"	1145	1
Square Fire Pit	12	36	44"	28"	36"	1545	1
Rivercrest							
Round Fire Pit	4	12	54"	36"	-	1512	1

# SEALERS, CLEANERS & SANDS

## PAVER CLEANERS



### POLYBIND™ OIL & GREASE CLEANER

Polybind Oil & Grease Cleaner is effective in removing oil and grease from the surface of concrete pavers and natural stones. Easy to use - dissolves, dislodges and removes oil and grease. No hydrochloric acid in product - washes off with water.

Packaging • 1 quart container (6 per carton, 24 cartons per pallet)

Note: Carefully read all instructions and safety information on product label prior to application. For additional safety information, see MSDS.



### POLYBIND™ EFFLORESCENCE CLEANER

Polybind Efflorescence Remover will remove any efflorescence stains trapped in the concrete paver and natural stone pores. It will make the pavers look more clean and vibrant. This efflorescence cleaning is a necessary step before a sealer is applied. The sealer will be able to get a deeper penetration into the now-clean pores.

Packaging • 1 & 5 gallon • Box of 4 x 1 US gallon (24 1 gal boxes & 48 5 gal pails per pallet)

Note: Carefully read all instructions and safety information on product label prior to application. For additional safety information, see MSDS.



### POLYBIND™ RUST CLEANER

Polybind Rust Cleaner is effective in removing rust from the surface of concrete pavers. Contains no muriatic acid.

Packaging • 1 quart container (6 per carton, 24 cartons per pallet)

Note: Carefully read all instructions and safety information on product label prior to application. For additional safety information, see MSDS.



### POLYBIND™ RUBBER, PAINT & TAR REMOVER

Polybind Rubber, Paint & Tar Remover is effective in removing rubber, paint and tar from the surface of concrete pavers and natural stone. Easily washes off with water and is easy to use.

Packaging • 1 quart container (6 per carton, 24 cartons per pallet)

Note: Carefully read all instructions and safety information on product label prior to application. For additional safety information, see MSDS.

## NATURAL STONE CLEANERS



### UNICARE NATURAL STONE ACID CLEAN

**NEW!**

1L and 5L

Removal of:

- Cement Staining
- Efflorescence
- Iron Oxide (Rust)
- Cement mortar
- Grout

Note: Never use hydrochloric or sulphuric acid based products. **ONLY FOR ACID RESISTANT STONE.**

Carefully read all instructions and safety information on product label prior to application. For additional safety information, see MSDS.



### UNICARE NATURAL POWER CLEAN

**NEW!**

1L and 5L

Removal of:

- Oil & Grease
- Food Stains
- General Dirt & Mud
- Light cement contamination (on acid sensitive surfaces)
- Sap & certain plant stains

Note: Carefully read all instructions and safety information on product label prior to application. For additional safety information, see MSDS.



### UNICARE BIOCLEAN

**NEW!**

1L and 5L

Removal of:

- Black spot algae
- Green algae
- Plant stains from leaves, wood, trees, berries & flowers
- Organic staining from bark & compost
- Colored stains from food spillages, tea, coffee and wine

Note: Carefully read all instructions and safety information on product label prior to application. For additional safety information, see MSDS.

## SEALERS



### POLYBIND™ WET LOOK SEALER

Polybind Wet Look Sealer is made from acrylic-based polymers. It penetrates deep into the concrete paver and natural stone pores, thus reducing the oil and dirt penetration, as well as protecting them from the corrosion of de-icing salt.

Packaging • 1 and 5 gallon available • Box of 4 x 1 US gallon (24 1 gal boxes & 48 5 gal pails per pallet)

Note: Carefully read all instructions and safety information on product label prior to application. For additional safety information, see MSDS.



### POLYBIND™ SATIN LOOK SEALER

Polybind Seal Satin Look is made from acrylic-based polymers. It penetrates deep into the concrete paver and natural stone pores, thus reducing the oil and dirt penetration, as well as protecting them from the corrosion of de-icing salt. Low-gloss matte finish, solvent-based.

Packaging • 1 and 5 gallon available • Box of 4 x 1 US gallon (24 1 gal boxes & 48 5 gal pails per pallet)

Note: Carefully read all instructions and safety information on product label prior to application. For additional safety information, see MSDS.



### POLYBIND™ ECO SEAL LOW GLOSS

Polybind Eco Seal Low Gloss is 100% pure, high-grade acrylic used to seal concrete pavers, clay pavers and natural stone. It penetrates deep into the pavers and natural stone pores, thus reducing the oil and dirt penetration, as well as protecting them from the corrosion of de-icing salt.

Packaging • 1 and 5 gallon available • Box of 4 x 1 US gallon (24 1 gal boxes & 48 5 gal pails per pallet)

Note: Carefully read all instructions and safety information on product label prior to application. For additional safety information, see MSDS.



### POLYBIND™ ECO SEAL HIGH GLOSS

Polybind Eco Seal High Gloss is 100% pure, high-grade acrylic used to seal concrete pavers, clay pavers and natural stone. It penetrates deep into the pavers and natural stone pores, thus reducing the oil and dirt penetration, as well as protecting them from the corrosion of de-icing salt.

Packaging • 1 and 5 gallon available • Box of 4 x 1 US gallon (24 1 gal boxes & 48 5 gal pails per pallet)

Note: Carefully read all instructions and safety information on product label prior to application. For additional safety information, see MSDS.

SEALERS

NATURAL STONE SEALERS



### UNICARE NATURAL STONE NATMATTE SEALER **NEW!**

1L and 5L

For Porous Stones

- No change of color
  - No surface coating, sheen or shine at all
  - Riven Sandstone & Smooth Sandstone
- Note: Carefully read all instructions and safety information on product label prior to application. For additional safety information, see MSDS.



### UNICARE NATURAL STONE NATCOLORENHANCE SEALER **NEW!**

1L and 5L

Color Enhancement For Porous Stones

- No surface coating, sheen or shine
- Breathable
- Lasts several years
- Easy to apply

Note: Carefully read all instructions and safety information on product label prior to application. For additional safety information, see MSDS.

## SEALERS (Continued)



### SUREBOND 1300 JOINT SAND STABILIZING SEALER - MATTE FINISH

Surebond Joint Stabilizing Sealer is an epoxy modified, single component VOC, EPA and OSHA compliant, solvent-free penetrating sealer that provides protection to interlocking paving stone installations against salt spray, acid rain, food and beverage stains, and other oxidizers. It binds joint sand together and ensures the integrity of the pavements by forming a homogeneous, flexible surface that stops erosion and joint sand failure in large paver installations. The sealer is also used to seal retaining walls and for concrete and aggregate and split-face stone to protect against staining salt spray and acid rain damage and discoloration for architectural, industrial, and residential installations.

Packaging • 1 and 5 gallon containers available • 55 gallon drum available on special order.

Note: Carefully read all instructions and safety information on product label prior to application. For additional safety information, see MSDS.



### SUREBOND 7000 JOINT STABILIZING SEALER - WET LOOK

Seals the surface and bonds joint sand between interlocking concrete pavers. Protects colored, stained and exposed aggregate concrete from staining. Resists acid, salt, other corrosives and weathering. Stabilizing Sealer is water based, single component and epoxy-modified. It exceeds all VOC and EPA standards. The product is non-hazardous and has the consistency of water. It is milky white in appearance when applied, and dries crystal clear creating a semi-gloss finish.

Packaging • 1 and 5 gallon available • 55 gallon drum available on special order

Note: Carefully read all instructions and safety information on product label prior to application. For additional safety information, see MSDS.



### SUREBOND 8700 WET LOOK JOINT SAND STABILIZER WITH FUNGICIDE

SB-8700 is an advanced premium acrylic sealer that will not yellow under exposure to sunlight. It's a 2 in 1 product; it protects the substrate surface and stabilizes jointing sand at the same time. Specially formulated with antifungal agents designed to help inhibit the growth of mold, fungi and moss on horizontal pavement surfaces, it forms a tenacious bond to the concrete or masonry surface. Wet look, Rain safe within 90 minutes, water repellent, breathable, solvent based.

Packaging:

- 1 gallon container
- 5 gallon pail (36 per skid)
- 55 gallon container (4 per skid)
- Box of 4 x 1 gallon containers (4 x 1 US gal)
- 36 cases per skid (of 1 gal)
- 80-120 sq.ft. coverage per gallon for pavers (approx.)\*
- 100-300 sq.ft. coverage per gallon for natural stone (approx.)\*

## ADHESIVES



### UNILOCK SB-10 ADHESIVE

10 oz - ADH009-1 / 28 oz RS-ADH015-1

10 oz. Tube: 20' at 1/4" bead (12/Case) (140 cs/skid) 28 oz. Tube: 52' at 1/4" bead (12/Case)(60 cs/skid)

SPECIFICATIONS - (Conforms to UN-STD. 1804, ASTM 2339-70& FHA UM-60)

Color: Natural Sand Color

Base: Rare Earths & High Strength Synthetic Rubbers & Resins

Weight: Over 8 lbs. Per Gallon (24 Cartridges at 26 lbs.)

Packaging: 1/10th Gallon Cartridges (10.5 Fl.Oz.)/12 per case

Staining: None

CLEANUP - Use mineral spirits or chlorinated solvents - read solvent suppliers caution notes for use of this product.

STORAGE - Store in cool place - Rotate stock - Keep at 70 °F for 24 hours before use in cold weather. Store cartridges in upright position.



### POLYBIND HIGH STRENGTH HP LOW VOC ADHESIVE

10 oz. Tube: (12/Case) (90 cs/skid) 28 oz. Tube: (12/Case)(60 cs/skid)

SPECIFICATIONS - (Exceeds ASTM D3498 and ASTM C557)

This is one of the strongest polyurethane adhesives on the market and is specially formulated for bonding concrete, natural stones, block, bricks and pavers. It is intended to provide a permanent bond to approved materials and can be used on dry or humid surfaces. Drying times vary depending on factors such as humidity, porosity, temperature and materials bonded together. VOC compliant / Low odor / Non-shrinking / Fast curing. Environmentally friendly, it replaces solvent-based adhesives and is safe to use indoors or outdoors.



### POLYBIND EXTRA PERFORMANCE ADHESIVE

10 oz. Tube: (12/Case) (90 cs/skid) 28 oz. Tube: (12/Case)(60 cs/skid)

SPECIFICATIONS

This is one of the strongest polyurethane adhesives on the market. It is especially formulated for bonding concrete, natural stones, blocks, bricks and pavers. It is intended to provide a permanent bond to approved materials and can be used on dry or humid surfaces. VOC compliant / Low odor / Non-shrinking / Fast curing. Environmentally friendly, it replaces solvent-based adhesives and is safe to use indoors or outdoors.

## SANDS



### POLYBIND HP SAND

Designed for paver joints up to a maximum of 1 inch.

Polybind HP Sand is a unique mixture of polymer binders and calibrated sand available in Nevada Tan and Oxford Grey. The installation of Polybind Sand is almost identical to using regular paver joint sand, except for the application of water. Once it sets, it becomes very firm and locks between the paver joints. This firm bond maintains pavers securely in place, being equally effective on both horizontal and sloped surfaces.

Packaging:

- 50 lb bag
- 56 bags per skid

Coverage:

- 65-85 sq.ft. per bag for narrow joints/larger joints will require more sand

## SANDS (Continued)



### POLYBIND COMPLETE SAND

Designed specifically for drainage and non-drainage base.

Polybind Complete Sand is specifically designed for drainage and non-drainage base systems. It can be used with concrete pavers, wetcast and natural stones. It is recommended for a variety of uses, including pool sides, patios foot paths, driveways, parking spaces, pavement, etc. This complete multi-purpose sand is available in three colors: Nevada Tan and Oxford Grey. It sets above the freezing temperature 32°F and can be used for joints up to a maximum of 1.5 in.

Packaging:

- 50 lb bag
- 56 bags per skid

Coverage:

- 65-85 sq.ft. per bag for narrow joints/larger joints will require more sand



### POLYBIND G2 SAND - NO DUST • HAZE FREE • NO BLOWER • ONE WATERING

Designed for paver and natural stone joints up to 2".

PolyBind G2 is made with calibrated sand that is mixed with sophisticated intelligent polymers, which neutralizes haze and dust. The polymeric sand application is now dust free and haze free. No blower is needed and the intelligent polymeric sand requires only one watering. It is recommended for a variety of uses including pool decks, patios, footpaths, driveways, parking spaces, pavements, etc. Available in Nevada and Oxford Grey. It sets above the freezing temperature 32°F and can be used for joints up to a maximum of 2 in.

Packaging:

- 50 lb bag

Coverage:

- 65-85 sq.ft. per bag for narrow joints/larger joints will require more sand



### POLYBIND G2 COMPLETE SAND - NO DUST • HAZE FREE • NO BLOWER • ONE WATERING

Designed for paver and natural stone joints up to 4" for overlay and non-overlay application.

PolyBind Complete G2 is made with calibrated sand that is mixed with sophisticated intelligent polymers, which neutralizes haze and dust. The polymeric sand application is now dust free and haze free. No blower is needed and the intelligent polymeric sand requires only one watering. It is recommended for a variety of uses including pool decks, patios, footpaths, driveways, parking spaces, pavements, etc. Available in Nevada, Oxford Grey, Ivory White and Jet Black. It sets above the freezing temperature 32°F and can be used for joints up to a maximum of 4 in.

Packaging:

- 50 lb bag

Coverage:

- 65-85 sq.ft. per bag for narrow joints/larger joints will require more sand
- 58-76 sq.ft. per bag for narrow joints/larger joints will require more sand (Jet Black)



### POLYBIND DUST

Designed for natural stone joints 1/2" to 4".

Polybind Dust is a unique mixture of polymer binders and calibrated crushed stone available in two colors - Tan & Grey. Once Polybind Dust sets, it becomes very firm and locks between the stone joints. This firm bond maintains the stones securely in place, being equally effective on both horizontal and sloped surfaces.

Packaging:

- 50 lb bag
- 56 bags per skid

Coverage:

- 20-30 sq.ft. per bag for joints 1"-2" wide and stones approximately 2" thick



### SUREBOND JOINTING SAND

This jointing sand will properly complete the interlocking of the segmental pavers because it is clean, angular and meets ASTM-C144 specifications. This type of sand is more stable in the paver joints and has the optimal gradation to ensure long term performance of the pavement system. Recommended for joints up to 3/4" • Washed, screened & dried • Available in tan & grey.

50 lb bag



### POLYSWEEP POLYMERIC SAND

PolySweep is designed to keep sand in the joints by creating a semi-solid joint. It is a blend of native sands conforming to (ASTM C-144) and binders specially formulated to allow the joints to expand and contract with the elements such as extreme heat, extreme cold and freeze/thaw cycles. Preventing sand erosion from the pavement joints caused by rain and other water run-off. PolySweep has not only proven to produce less hazing, but it also deters weed growth and reduces overall pavement maintenance.

Max width: 2.5 cm (1"); a larger joint width is acceptable where the pavers intersect. Min depth: 3 cm (1.25").

50 lb/bag, 56 Bags/Skid (2,860 lbs/skid)

Available Colors: Grey and Tan

Coverage: Approx. Courtstone® - 1 bag covers approximately 25 sq. feet.

**Note:** Extra care must be exercised when using on Courtstone®, Copthorne®, Richcliff® and Town Hall®. This product is not recommended for Il Campo®, Series™, Unigranite® and Umbriano®.

## SANDS (Continued)

PAVERS \ FEATURES	SAND RECOMMENDATIONS BY PRODUCT			
	Polybind HP G2	Polybind Complete Sand G2	Polysweep Polymeric Sand	Unicare® Easy Pro®
	For joints up to 1/8" May be sealed. Tan color Non-binding sand	For joints up to 1" May be sealed. Available in Tan or Grey Binding sand	For joints up to 4" May be sealed. Available in Tan or Grey Binding sand	For joints up to 1" May be sealed. Available in Tan or Black Binding sand
Avante Ashlar™	N/R	✓	✓	✓
Copthorne®	✓	✓	✓*	✓
Courtstone®	✓	✓	✓	✓
Il Campo®	N/R	N/R	N/R	N/R
Richcliff®	✓	✓	✓*	✓
Rivenstone™	N/R	✓	✓	✓
Senzo™	✓	✓	N/R	N/R
Series™	N/R	N/R	N/R	N/R
Town Hall®	✓	✓	✓	✓
Umbriano®	✓	✓	N/R	N/R
Unigranite®	N/R	N/R	N/R	N/R
Tumbled Pavers	✓	✓	✓	N/R
Standard Pavers	✓	✓	✓	✓

N/R - Not Recommended

✓ - Recommended

✓\* - These pavers have a very narrow or slightly angled edge (chamfer), limiting sand penetration in the joint and causing possible weak bonding areas. The life cycle performance could be affected.

### IMPORTANT NOTICE

1. **DO NOT USE** Polymeric Jointing Sand on the following products:

Series™ Il Campo® Unigranite®

If joint stabilization is required, use ordinary jointing sand and apply a stabilizing sealer. **Contact your local Unilock office for recommended sealants and application specifics.**

2. **EXTRA CARE** must be exercised when using Polymeric Sand on the following products:

Courtstone® Copthorne® Richcliff® Town Hall® Umbriano®

Polymeric Jointing Sand can be used on these products but the fine polymers and binders in Polymeric Jointing Sand have a natural tendency to adhere to the surface and therefore extra diligence must be taken to pre-clean the surface prior to "wetting the sand in" and squeegee off the surface post application. Failure to do so will result in a "whitish haze" on the surface that is difficult to remove.

3. **IMPORTANT COMPACTION NOTICE:** Always pre-compact the pavers WITHOUT SAND IN THE JOINTS. This will facilitate proper leveling. Polymeric sand can then be swept into the joints. *Always use a compactor with a protective membrane attached to the bottom of the plate.*

Polymeric Jointing Sand, cleaners and sealers, **must** always be applied by a trained and experienced professional. **Contact your local Unilock office for training and the most up-to-date best practices.**

NOTICE: Unilock does not accept any responsibility for damage to the surface caused by the improper application and use of polymeric sand, sealers or cleaners. Unilock will not accept responsibility for alternate suppliers of polymeric sand, jointing sand, cleaners and sealers.

## EDGE RESTRAINT

### SNAPEDGE - ONE-PIECE EDGING THAT DOES IT ALL!

- Only one part required for straight runs or curved installations.
- Built-in connector fastens one piece to the next - convenient 96" size, makes them easy to transport.
- Unique 'Snip and Flex' feature speeds installations of curves and corners without pre-planning.
- The open design allows a root system to grow through SnapEdge, further reinforcing the installation.
- Engineered to provide a strong, easy-to-install edge restraint for concrete/clay pavers.
- Nail hole bosses are full-length cylinders. Hammer blows will not fracture or force nail heads through edging.
- Also available in low profile for use with Rivenstone™, Yorkstone™ and natural stone materials.

1. SnapEdge
2. 10" Spiral Spike
3. Soil
4. Turf
5. Sand Jointed Paver
6. Sand Jetting Course
7. Aggregate Base
8. Compacted Subgrade

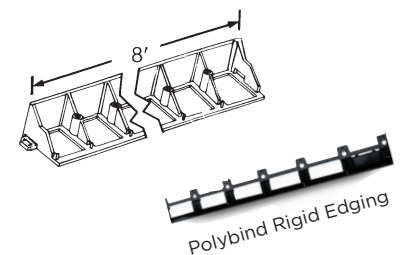
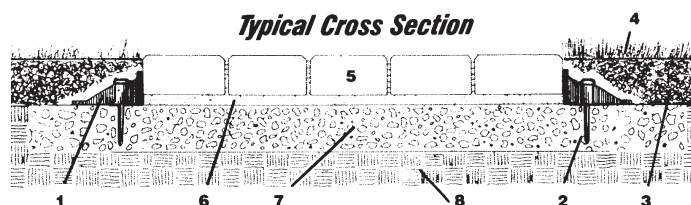



## EDGE RESTRAINT (Continued)

### TIPS FOR QUICK AND EASY INSTALLATION WITHOUT PRE-PLANNING

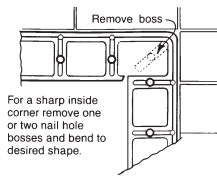

Sharp Inside Corner

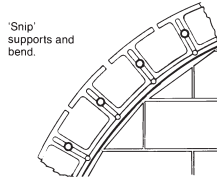

Gentle Outside Curves

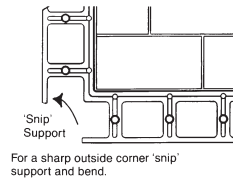

Sharp Outside Corner

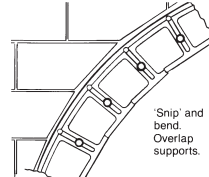

Gentle Inside Curves

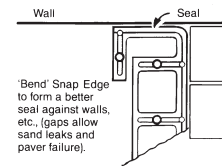

Proper Wall Installation

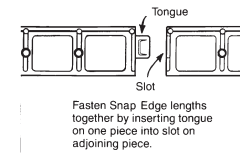

Pieces Snap Together

## LANDSCAPE BASE, FABRICS AND GRIDS



### POLYBIND GATOR BASE

- 57.9 Sq.Ft./Pkg

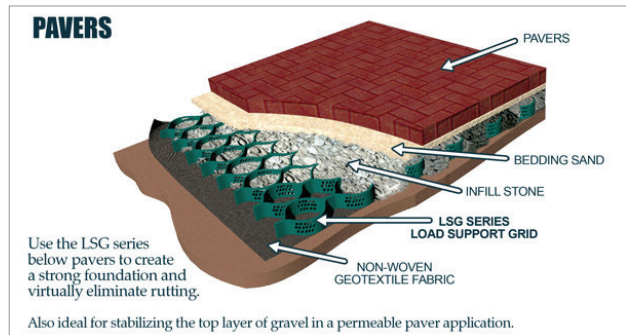

### CELL TEK 3" & 4" LOAD SUPPORT GRID

- 170 Sq.Ft./Pkg (9' x 24')



### UNILock DRIVEGRID™ SYSTEM

- 120' x 13' Roll, 1,572 Sq.Ft./Roll
- 56 lb/Roll



### GATOR GRID

- GG 30-30 (4' x 50') Biaxial Grid/ 16 rolls/box
- GG 30-30 (6' x 150') Biaxial Grid/ 20 rolls/pallet



### GATOR FABRIC

- GF3.5 Non-Woven 3' x 100' 4 roll pkg
- GF3.5 Non-Woven 6' x 100' 12 roll pkg
- GF8 Polyspun (3' x 100') / 9 rolls/box

# TOOLS & ACCESSORIES



- Install up to 700 sq. ft. per hour!
- Access tight or narrow areas
- Eliminate the need for a forklift on site
- Reduce labor costs
- Reduce shoulder, hand & knee pain and injury
- Improve your bottom line

Contact your local rep for details

## ATLANTIC WATERFALLS KIT

24" blue waterfall  
 MODEL CF24B/CF24W/CF24R/CF24SW

- 12 Volt
- 20 watts
- 1 1/4" FIPT inlet
- 2000 gph flow rate
- 5" lip extension
- 30' cord and trans
- 24" x 8" w x 3 1/2" h

\*Recommended for clean water and pond-free applications only\*

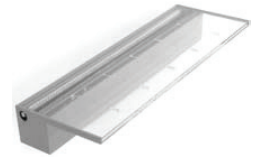

## 4 LB. SPLITTING HAMMER

Used with Chisel and/or Wall Splitter.



## PISA XL LIFTING TONG

The Pisa XL tong makes it easier to lift and place units, especially on the base course. The action of lifting the handle secures the lifter and makes for easy, balanced lifting and placement.

## 4" CHISEL WITH HAND GUARD

Tapered on both sides for more controlled splitting.



## PISA2® LEVEL

Used for leveling Pisa2, Roman Pisa and Split'n Stack wall systems.

## U-LEVEL™ NEW

- Easy to use
- Accurate readings
- Low maintenance
- Works in difficult locations
- Large working area



A PRECISION TOOL NO HARDCAPER SHOULD BE WITHOUT



## PAVER PULLER

Used for extracting pavers.

## CUTTING EQUIPMENT

### UNILOCK PAVER PRO

Industrial Diamond Blades which have been specifically engineered for the needs of the Professional Segmental Contractor.

Blades available in two sizes: 12" x 0.110  
 14" x 0.110



## FIRE ROCK FIREPLACE

### PRE-ENGINEERED MASONRY FIREPLACE AND CHIMNEY SYSTEM

The Fire Rock Masonry Fireplace and Chimney System is a pre-engineered refractory components kit system. Fire Rock products represent the latest technology in safe, high-performance, all-masonry fireplaces and chimneys. In recent years, many architects and landscape firms have utilized Fire Rock for outdoor rooms and patios.

Firebox		36"
Overall Width	A	44
Overall Depth	B	28.5
Firebox Height	C	38
Smoke Ch. Ht.	D	32.125
Opening Width	E	38.5
Opening Height	F	32.125
Firebox Depth	G	22.75
Width at Top		26
Width at Rear		27.875

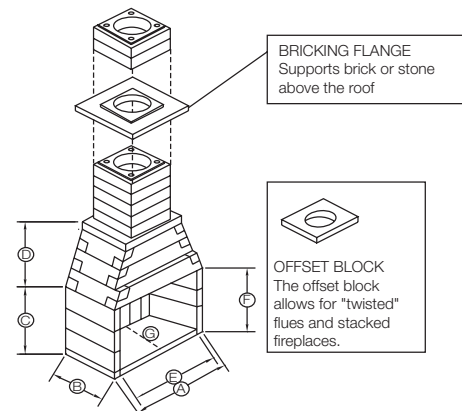

## TOOLS AND ACCESSORIES

ADHESIVES	UNIT
SB PaverBond Adhesive Tube (10.5 oz)	12 per case
SB PaverBond Adhesive Tube (29 oz)	12 per case
PolyBind High Strength HP Low VOC (10 oz)	12 per case
PolyBind High Strength HP Low VOC (28 oz)	12 per case
PolyBind High Strength XP Low VOC (10 oz)	12 per case
PolyBind High Strength XP Low VOC (28 oz)	12 per case

POLYMERIC AND JOINTING SANDS	UNIT
SB Jointing Sand Tan or Grey	Per Bag
SB Polysweep Polymeric Sand Tan or Grey	Per Bag
PolyBind HP Beige or Slate Grey	Per Bag
PolyBind Complete Beige or Slate Grey for overlays	Per Bag
PolyBind G2 Beige or Slate Grey	Per Bag
PolyBind G2 Complete Beige, Slate Grey, Ivory or Jet Black	Per Bag
PolyBind Euro Beige or Slate Grey for Wetcast and Courtstone	Per Bag
PolyBind Dust Sahara Beige and Stone Grey	Per Bag
SB Permeable Jointing Chip - Granite Chips - Tan, Grey or Black	Per bag
PolyBind Eco Rock Granite Grey	Per bag

CLEANERS & SEALERS	UNIT
PolyBind Wet Look Sealer (Solvent Base)	1 & 5 Gallon
PolyBind Satin Look Sealer (Solvent Base)	1 & 5 Gallon
PolyBind Eco Sealer High Gloss (Water Base)	1 & 5 Gallon
PolyBind Eco Sealer Low Gloss (Water Base)	1 & 5 Gallon
SB1300 Joint Stabilizer Sealer 1 GL (Natural Look-water base)	1, 5 & 55 Gallon
SB7000 Joint Stabilizer Sealer 1 GL (Wet Look-water base)	1, 5 & 55 Gallon
SB8700 Joint Stabilizer Sealer 1 GL (Wet Look-solvent base)	1, 5 & 55 Gallon
SB-Sure Strip 1GL	1 Gallon
SB-Efflo Off 1 GL (concentrated-dilution required)	1 Gallon
PolyBind Efflorescence Cleaner (dilute 4:1)	1 Gallon
PolyBind Shampoo	1 Gallon
PolyBind Rust Remover	1 Quart
PolyBind Oil and Grease Remover	1 Quart
PolyBind Paint, Tar and Rubber Remover	1 Quart

COMPACTION EQUIPMENT	UNIT
Hand Tamper	Each
Universal Urethane Mat	Each

CUTTING DEVICES	UNIT
Diamond Blade 12" x .110 (regular)	Each
Diamond Blade 14" x .110 (regular)	Each
Chisel with Hand Guard	Each

DECK OVERLAY SYSTEM	UNIT
Plastic trays for transforming wood decks to paver decks (16"x18"=2 SF/per each)	Each

FABRICS AND GRIDS	UNIT
PolyBind Gator Base (57.9 sf/pkg)	Package
Cell Tek 3" Load Support Grid 170 SQ.FT. (9'x24')	Each
Cell Tek 4" Load Support Grid 170 SQ.FT. (9'x24')	Each
Gator Fabric GF3.5 Non-Woven (3' x 100') For Pavers and Retaining Walls (4 rolls/box)	Per Roll
Gator Fabric GF3.5 Non-Woven (4' x 100') For Pavers and Retaining Walls (4 rolls/box)	Per Roll
Gator Fabric GF3.5 Non-Woven (6' x 100') For Pavers and Retaining Walls (4 rolls/box)	Per Roll
Gator Fabric GF3.5 Non-Woven (6' x 300') For Pavers and Retaining Walls (12 rolls/pallet)	Per Roll
Gator Fabric GF8 Polyspun (3' x 100') For Landscape Coverings (9 rolls/box)	Per Roll
Gator Grid GG 30-30 (4' x 50') Biaxial Grid (16 rolls/box)	Per Roll
Gator Grid GG 30-30 (6' x 150') Biaxial Grid (20 rolls/pallet)	Per Roll
Strata Grid 200 (6'x300')	Per Sq. Ft.
Unilock Drive Grid - Roll Size (13.1'x120')	Per Sq. Ft.

## TOOLS AND ACCESSORIES continued

EDGE RESTRAINTS	UNIT
Snap Edge (8'/pc)	Piece
Low Profile Snap Edge (6'8"/pc)	Piece
PermEdge Permeable Edging (8'/pc)	Piece
PolyBind Edge Rigid (8'/pc)	Piece
Spikes - Spiral Ardox 10"	Each

FIRE PITS	UNIT
Rivercrest Firepit complete with Insert and grilling rack and all Rivercrest product	Each
Sunset Round Firepit complete with Insert and 54 pieces of Dimensional Stone	Each
Sunset Round Firepit Insert only	Each
Sunset Square Firepit complete with Insert and 36 pieces of Dimensional Stone	Each
Sunset Square Firepit Insert only	Each

HAMMERS	UNIT
Drilling Hammer 4 lb.	Each

HANDLING EQUIPMENT	UNIT
Pisa XL Lifting Tong	Each
Paver Extractor	Each
Paver Vacuum (PM1)	Each
Paver Vacuum (PM3)	Each

LANDSCAPING SCREEDS	UNIT
Magnesium Screed 4' x 1" x 4"	Each
Magnesium Screed 6' x 2" x 4"	Each
Magnesium Screed 8' x 2" x 4"	Each

LIMESTONE CAPS	UNIT
Limestone Caps 24" x 24" x 3"	Each
Limestone Caps 28" x 28" x 3"	Each
Limestone Caps 32" x 32" x 3"	Each

LEVELING	UNIT
Pisa Level	Each
U-LEVEL	Each
Mighty "T" Level	Each
Shims Case (36 sheets of 10 per case)	Case
Shims Sheets (10 shims per sheet)	Sheet of 10

FIREPLACE KIT	UNIT
36" Outdoor Environment Kit (includes 2 bags of mortar)	Each
42" Outdoor Environment Kit (includes 2 bags of mortar)	Each
Additional 6' chimney extensions	Each
25lb bag of mortar	Each

NATURAL STONE	UNIT
Indian Coast Project Pack (12x24,18x24,24x24,24x36)	Square Foot
Indian Coast 24x36 & 24x24	Square Foot
Indian Coast Coping 12x48x2 (Natural Edge and Bullnose)	Each
Black River Project Pack (12x24,18x24,24x24,24x36)	Square Foot
Black River 24x36 & 24x24	Square Foot
Black River Coping 12x48x2 (Natural Edge & Bullnose)	Each
Stonecliff Grey Project Pack (12x24,18x24,24x24,24x36)	Square Foot
Stonecliff Grey 24x36 & 24x24	Square Foot
Stonecliff Grey Coping 12x48x2 (Natural Edge & Bullnose)	Each
Winter Mist Project Pack (12x24, 18x24, 24x24, 24x36)	Square Foot
Winter Mist 24x36 & 24x24	Square Foot
Winter Mist Coping 12x36x2 (Natural Edge & Bullnose)	Each

## TOOLS AND ACCESSORIES continued

### NATURAL STONE SEALERS AND CLEANERS

### UNIT

UniCare Natural Stone Acid Clean for Sandstone or Limestone (NOT for Black Limestone)	5 litre
UniCare Natural Stone Acid Clean for Sandstone or Limestone (NOT for Black Limestone)	5 litre
UniCare Natural Power Clean for Sandstone or Limestone	5 litre
UniCare Natural Power Clean for Sandstone or Limestone	1 litre
UniCare BioClean for Sandstone or Limestone	5 litre
UniCare BioClean for Sandstone or Limestone	5 litre
UniCare Natural Stone NatMatte Sealer	5 litre
UniCare Natural Stone NatMatte Sealer	1 litre
UniCare Natural Stone NatMatte Sealer	5 litre
UniCare Natural Stone NatMatte Sealer	1 litre

### PEDESTALS

### UNIT

VT18 Ultra Low Height Pedestals 1/8" Height with 1/8" Joint	Each
HD50-18 Fixed 1/2" Height Stackable Pedestals with 1/8" Joint	Each
LO18 Low Height (1.25"-2") Adjustable Pedestals with 1/8" Joint	Each
V1 Adjustable Pedestals 2.25"-2.75" Height with 1/8" Joint	Each
V2 Adjustable Pedestals 2.75"-3.75" Height with 1/8" Joint	Each
V3 Adjustable Pedestals 3.75"-5.75" Height with 1/8" Joint	Each
V4 Adjustable Pedestals 5.75"-9.00" Height with 1/8" Joint	Each
B11 Rubber shim 1/16" thick	Each

### PORCELAIN PAVERS

### UNIT

Arbor Bianco	Square Foot
Arbor Gray	Square Foot
Arbor Natural	Square Foot
LaScala Beige	Square Foot
LaScala Gray	Square Foot
Dolomiti Beige	Square Foot
Dolomiti Grey	Square Foot
Dolomiti Natural	Square Foot
Dolomiti Noce	Square Foot
Epokal Beige Scuro	Square Foot
Epokal Beige	Square Foot
Epokal Grey	Square Foot
Gotham Beige	Square Foot
Gotham Grey	Square Foot
Gotham Nero	Square Foot
Travstone Beige	Square Foot
Travstone Noce	Square Foot

### UNILOCK PRE-BUILT ELEMENTS

### UNIT

Moda Fireplace Granite/Opal BS+TP	Each
Bella Fireplace Coastal Slate/Granite BS+TP	Pair
Tuscany Wood Fireplace (Sierra or Sandstone w/Copthorne accents)	Each
Tuscany Wood Boxes (2) (Sierra or Sandstone w/Copthorne accents)	Pair
Tuscany Arched Hearth (Sierra or Sandstone w/Copthorne accents)	Each
Tuscany Brick Oven (Sierra or Sandstone w/Copthorne accents)	Each
Tuscany Grill (with stainless grill and doors) (Sierra or Sandstone w/Copthorne accents)	Each
Barcelona Wood Fireplace (River w/Richcliff accents)	Each
Barcelona Wood Boxes (2) (River w/Richcliff accents)	Pair
Barcelona Arched Hearth (River w/Richcliff accents)	Each
Bella Grill	Each

### WATERFALL KITS

### UNIT

Color waterfalls kit 24" (white or blue)	Each
--	------

# CALCULATIONS

## AREA OF A CIRCLE

Radius (in.)	18	21	24	27	30	33	36	39	42	45	48	51	54	57
Radius (ft.)	1.50	1.75	2.00	2.25	2.50	2.75	3.00	3.25	3.50	3.75	4.00	4.235	4.50	4.75
Square Feet	7.07	9.62	12.56	15.90	19.63	23.75	28.26	33.17	38.47	44.16	50.24	56.72	63.59	70.85
Circumference (in.)	113.04	131.88	150.72	169.56	188.40	207.24	226.08	244.92	263.76	282.60	301.44	320.28	339.12	357.96
Circumference (Ft.)	9.42	10.99	12.56	14.13	15.70	17.27	18.84	20.41	21.98	23.55	25.12	26.69	28.26	29.83

Area of a circle = 3.14 x Radius x Radius

Circumference = 6.28 x Radius

## AREA CONVERSION CHART

Square Feet	1	2	3	4	5	6	7	8	9	10	11	12	13	14
Square Meter	0.09	0.19	0.28	0.39	0.46	0.56	0.65	0.74	0.84	0.93	1.02	1.11	1.21	1.30
Square Meter	1	2	3	4	5	6	7	8	9	10	11	12	13	14
Square Feet	10.76	21.53	32.29	43.06	53.82	64.58	75.35	86.11	96.88	107.64	118.40	129.17	139.93	150.69
Cubic Yard	1	2	3	4	5	6	7	8	9	10	11	12	13	14
Cubic Feet	27	54	81	108	135	162	189	216	243	270	297	324	351	378

Area Square = Length x Width

Area Triangle = 1/2 Base x Height

## LINEAR DISTANCE CONVERSION CHART

Inches	1	2	3	4	5	6	7	8	9	10	11	12	13	14
Centimeters	2.54	5.08	7.62	10.16	12.70	15.24	17.78	20.32	22.86	25.40	27.94	30.48	33.02	35.53
Centimeters	1	2	3	4	5	6	7	8	9	10	11	12	13	14
Inches	0.39	0.79	1.18	1.57	1.97	2.36	2.76	3.15	3.54	3.94	4.33	4.72	5.12	5.51
Feet	1	2	3	4	5	6	7	8	9	10	11	12	13	14
Meters	0.30	0.61	0.91	1.22	1.52	1.83	2.13	2.44	2.74	3.05	3.35	3.66	3.96	4.25
Meters	1	2	3	4	5	6	7	8	9	10	11	12	13	14
Inches	39.37	78.74	118.11	157.48	196.85	236.22	275.59	314.96	354.33	393.70	433.07	472.44	511.81	551.18
Feet	3.28	6.56	9.84	13.12	16.40	19.69	22.97	26.25	29.53	32.81	36.09	39.37	42.65	45.93

## WEIGHT CONVERSION CHART

Pounds	1	2	3	4	5	6	7	8	9	10	11	12	13	14
Kilograms	0.45	0.91	1.36	1.81	2.27	2.72	3.18	3.63	4.08	4.54	4.99	5.44	5.90	6.35
Kilograms	1	2	3	4	5	6	7	8	9	10	11	12	13	14
Pounds	2.20	4.41	6.61	8.82	11.02	13.23	15.43	17.64	19.84	22.05	24.25	26.46	28.66	30.86

Calculation charts and formulas are provided as a service by Unilock for estimating material requirements. Unilock will not be held responsible in any way for resulting product overage or shortage.

## BEDDING MATERIALS CHART (APPROXIMATE IMPERIAL TONS)

Square Feet	Bedding Course											
	1"	2"	3"	4"	5"	6"	7"	8"	9"	10"	11"	12"
50	0.3	0.5	0.8	1.0	1.3	1.5	1.8	2.0	2.3	2.5	2.8	3.0
100	0.5	1.0	1.5	2.0	2.5	3.0	3.5	4.0	4.5	5.0	5.5	6.0
150	0.8	1.5	2.3	3.0	3.8	4.5	5.3	6.0	6.8	7.5	8.3	9.0
200	1.0	2.0	3.0	4.0	5.0	6.0	7.0	8.0	9.0	10.0	11.0	12.0
250	1.3	2.5	3.8	5.0	6.3	7.5	8.8	10.0	11.36	12.5	13.8	15.0
300	1.5	3.0	4.5	6.0	7.5	9.0	10.5	12.0	13.5	15.0	16.5	18.0
350	1.8	3.5	5.3	7.0	8.8	10.5	12.3	14.0	15.8	17.5	19.3	21.0
400	2.0	4.0	6.0	8.0	10.0	12.0	14.0	16.0	18.0	20.2	22.0	24.0
450	2.3	4.5	6.8	9.8	11.3	13.5	15.8	18.0	20.3	22.5	24.8	27.0
500	2.5	5.0	7.5	10.0	12.5	15.0	17.5	20.0	22.5	25.0	27.5	30.0
550	2.8	5.5	8.3	11.0	13.8	16.5	19.3	22.0	24.8	27.5	30.3	33.0
600	3.0	6.0	9.0	12.0	15.0	18.0	21.0	24.0	27.0	30.0	33.0	36.0
650	3.3	6.5	9.8	13.0	16.3	19.5	22.8	26.0	29.3	32.5	35.8	39.0
700	3.5	7.0	10.5	14.0	17.5	21.0	24.5	28.0	31.5	35.0	38.5	42.0
750	3.8	7.5	11.36	15.0	18.8	22.5	26.3	30.0	33.8	37.5	41.3	45.0
800	4.0	8.0	12.0	16.0	20.0	24.0	28.0	32.0	36.0	40.0	44.0	48.0
850	4.3	8.5	12.8	17.0	21.3	25.5	29.8	34.0	38.3	42.5	46.8	51.0
900	4.5	9.0	13.5	18.0	22.5	27.0	31.5	36.0	40.5	45.0	49.5	54.0
950	4.8	9.5	14.3	19.0	23.8	28.5	33.3	38.0	42.8	47.5	52.3	57.0
1000	5.0	10.0	15.0	20.0	25.0	30.0	35.0	40.0	45.0	50.0	55.0	60.0

Actual volume may vary due to type of materials, moisture content, and compaction. Calculation charts and formulas are provided as a service by Unilock for estimating material requirements. Unilock will not be held responsible in any way for resulting product overage or shortage.

## BASE DEPTH CHARTS (CUBIC YARDS)

Square Feet	Bedding Course											
	1"	2"	3"	4"	5"	6"	7"	8"	9"	10"	11"	12"
50	0.2	0.3	0.5	0.6	0.8	0.9	1.1	1.2	1.4	1.5	1.7	1.9
100	0.3	0.6	0.9	1.2	1.5	1.9	2.2	2.5	2.8	3.1	3.4	3.7
150	0.5	0.9	1.4	1.9	2.3	2.8	3.2	3.7	4.2	4.6	5.1	5.6
200	0.6	1.2	1.9	2.5	3.1	3.7	4.3	4.9	5.6	6.2	6.8	7.4
250	0.8	1.5	2.3	3.1	3.9	4.6	5.4	6.2	6.9	7.7	8.5	9.3
300	0.9	1.9	2.8	3.7	4.6	5.6	6.5	7.4	8.3	9.3	10.2	11.1
350	1.1	2.2	3.2	4.3	5.4	6.5	7.6	8.6	9.7	10.8	11.9	13.0
400	1.2	2.5	3.7	4.9	6.2	7.4	8.6	9.9	11.1	12.3	13.6	14.8
450	1.4	2.8	4.2	5.6	6.9	8.3	9.7	11.1	12.5	13.9	15.3	16.7
500	1.5	3.1	4.6	6.2	7.7	9.3	10.8	12.3	13.9	15.4	17.0	18.5
550	1.7	3.4	5.1	6.8	8.5	10.2	11.9	13.6	15.3	17.0	18.7	20.4
600	1.9	3.7	5.6	7.4	9.3	11.1	13.0	14.8	16.7	18.5	20.4	22.2
650	2.0	4.0	6.0	8.0	10.0	12.0	14.0	16.0	18.1	20.1	22.1	24.1
700	2.2	4.3	6.5	8.6	10.8	13.0	15.1	17.3	19.4	21.6	23.8	25.9
750	2.3	4.6	6.9	9.3	11.6	13.9	16.2	18.5	20.8	23.1	25.5	27.8
800	2.5	4.9	7.4	9.9	12.3	14.8	17.3	19.8	22.2	24.7	27.2	29.6
850	2.6	5.2	7.9	10.5	13.1	15.7	18.4	21.0	23.6	26.2	28.9	31.5
900	2.8	5.6	8.3	11.1	13.9	16.7	19.4	22.2	25.0	27.8	30.6	33.3
950	2.9	5.9	8.8	11.7	14.7	17.6	20.5	23.5	26.4	29.3	32.3	35.2
1000	3.1	6.2	9.3	12.3	15.4	18.5	21.6	24.7	27.8	30.9	34.0	37.0

Actual volume may vary due to type of materials, moisture content, and compaction. Calculation charts and formulas are provided as a service by Unilock for estimating material requirements. Unilock will not be held responsible in any way for resulting product overage or shortage.

# IMPORTANT NOTES

## UNILOCK PAVER PATTERNS

This Product Data Guide contains an extensive reference to patterns and designs. The purpose of these pattern swatches is to help the designer plan unique and exceptional designs. The percentages of products shown are based on the pattern and not on bundle configurations. In fact, there may be situations in which a pattern has been created with one particular size of stone, but that stone only comes packaged with two other sizes. This means that the designer will have to plan how the other components are used in the overall plan. This is usually accomplished by adding a border or an accent. As a result, overages or shortages may occur in certain patterns. The designer and/or installer of Unilock products accepts all responsibility for design and all associated costs incurred as a result of applying any of Unilock's suggested design patterns in a project. Please plan your project and review your order carefully prior to ordering.

## TRANSFERABLE LIFETIME GUARANTEE

Unilock provides a Transferable Lifetime Guarantee\* on the structural integrity of our paving stones, slabs and retaining wall units to the original purchaser of the product for residential use. Any materials installed and maintained to our guidelines, and subject to normal wear, that prove defective, will be replaced without cost. Color matching cannot be guaranteed and replacement labor is not included. Proof of purchase is required.

Excessive defective material (over the industry accepted normal of 2% for non-tumbled unit pavers) delivered to the purchaser will be replaced free of charge if a written claim is made within 5 days of delivery from the manufacturer. Such claims will not constitute reason for delaying payment. All goods shall be deemed accepted if completely installed. Inspect concrete products prior to opening bundle packaging to ensure that shape and color are as ordered. Unsatisfactory material must be available for inspection by Unilock to entitle the purchaser to any adjustment or credit. Inspect all concrete units during installation and set aside any which are chipped or cracked to use for any cut pieces required. The color of concrete products may vary significantly between production lots. Always install concrete units from several bundles simultaneously to ensure proper distribution of color. Prior to final compaction, inspect installed pavers for good color distribution. Relocate certain pavers, if necessary, to achieve desired color blend.

\*Transferable Lifetime Guarantee: Register your project within 60 days of your dated proof of purchase to ensure your Unilock Guarantee is fully transferable! Simply go online at [unilock.com](http://unilock.com) and follow instructions. Once processed, you will receive an original Transferable Warranty Certificate for your records.

## PRODUCT HANDLING WARNING

**Bundle Straps Under Tension - Use extreme caution when removing or handling straps.** Always wear gloves, goggles, safety footwear, and protective clothing when removing or handling straps. Failure to do so may result in serious bodily injury or loss of sight. Cut all concrete products only in well ventilated areas. Inhalation of dust is a serious health risk. A "NIOSH" (US) or a "CSA" (CDN) approved respirator, safety goggles, hearing protectors, and gloves must be worn at all times. Always "wet-cut" or "wet grind" concrete products to minimize dust.

Do not stack bundled concrete products higher than 2 bundles high. Contents of the bundle may be unstable and subject to topple when stacked. Always use extreme caution and appropriate equipment when transporting or storing bundled concrete products. Failure to do so may result in serious bodily injury or death. Always obey gross vehicle weight (GVW) loading limitations and regulations.

Hazard Rating: Fire 0, Health 1, Reactivity 0. See MSDS Concrete Masonry (Pavers). Contact Unilock for complete sheet or view safety information at [www.unilock.com](http://www.unilock.com).

*Unilock assumes no liability or responsibility for loss or damage, resulting from the improper use or handling of our products, or from failure to follow instructions, warnings, and/or advisories on the product label, and on the MSDS sheet.*

## TRADEMARK AND LEGAL INFORMATION

Umbriano® is a trademark of Metten Stein + Design GmbH & Co KG used under license by Unilock.

Unilock Ltd. and Hengestone Holdings, Inc. are the owners or authorized users of all trademarks used in this publication unless otherwise specified.

Measurements throughout this portfolio are nominal.

\*Colors shown in this catalog should be used only as a guide. Colors should always be chosen from actual samples. Contact your local Unilock representative for color availability in your area.

Not all products shown are available at all Unilock locations. Log on to [www.unilock.com](http://www.unilock.com) for availability.

©2019 Hengestone Holdings, Inc.

1-800-UNILOCK

[www.unilock.com](http://www.unilock.com)



## FINISHES

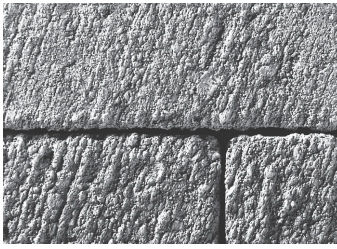

BRUSHED



COBBLESTONE



WEATHERED



DIMPLED AND WEATHERED



FLAGSTONE



SMOOTH



WASHED

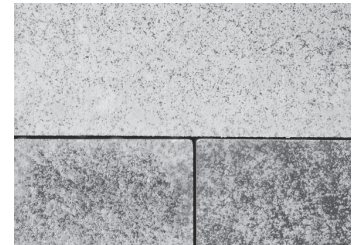

SMOOTH - ZERO BEVEL

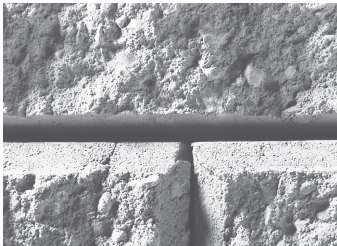

SPLIT



TIMEWORN



SPLIT AND WEATHERED



STANDARD

## COLOR BLEND DESCRIPTIONS

COLOR NAME	DESCRIPTION
Basalt	Blue-Black
Bavarian Blend	White, Buff and Charcoal
Birch	Dark Brown, Light Brown & Cream
Bluestone	Blue with Black and Brown veining
Canyon	Plum, Yellow-Brown
Castano	Dark Brown and Burnt Brown blend
Coastal Slate	Grey and Tan
Cobalt Grey	White, Grey and Blue hues
Coffee Creek	Buff, Charcoal, Mauve
Cream	Creamy Buff
Crema	Cream and Buff
Dawn Mist	Grey and Tan
Fossil	White, Grey, Charcoal & Camel
French Grey	Light Grey
Graphite	Mid Black
Granite	Charcoal and Natural
Golden Tan	Dark Brown, Light Brown with White Granite
Heritage Clay	Burnt Clay and Basalt

COLOR NAME	DESCRIPTION
Heritage Red	Burgundy Red and Basalt
Mineral Ice Grey	Grey and White
Limestone	Light Grey
Midnight Sky	Charcoal and Black Flake
Mocha	Dark Brown
Nevada	Buff and Natural
Nuvola	Dark Charcoal and Light Grey
Onyx Black	Dark Charcoal with Black Granite
Pebble Taupe	Tan and Brown
River	Buff, Natural and Charcoal
Rustic Red	Red and Charcoal
Sandstone	Light Buff
Sierra	Buff, Charcoal and Brown
Slate Blue	Blue, with mauve and buff accents
Steel Grey	Charcoal and Light Grey
Summer Wheat	Cream White with Pale Yellow & Beige Particles
Walnut	Dark Brown, Light Brown and Buff accents
Winter Marvel	White and Black Flake

UNIT PAVERS

Product	Page	Finish	Pedestrian	Residential Vehicular	Commercial Vehicular	Environmental	For Borders & Accents
Artline™	2	SM	✓				✓
Avante Ashlar™	3	F	✓	✓			
Beacon Hill™ Classic	3	F	✓				
Beacon Hill™ Flagstone	4	F	✓				
Beacon Hill™ Smooth	4	SM	✓				
Boulevard	5	F	✓	✓			✓
Bristol Valley®	5	S	✓				
Brussels Block®	6	W	✓	✓			✓
Camelot™ & Tumbled Camelot™	6	S	✓	✓	✓		✓
Cophthorne®	7	T	✓	✓			✓
Courtstone®	8	C	✓	✓			✓
Eco-Optiloc™	8	S	✓	✓	✓	✓	
Eco-Priora™ - Standard finish	9	S	✓	✓	✓	✓	
Granito	10	S	✓	✓			
Holland Premier™	11	S	✓	✓	✓		✓
Hollandstone™	11	S	✓	✓	✓		✓
Il Campo®	12	B	✓	✓	✓		✓
Mattoni	12	F	✓	✓			✓
Natural Stone	13		✓				
Optiloc®	15	S	✓	✓	✓		
Porcelain Tile	14		✓				
Promenade™	15	S	✓	✓	✓		
Richcliff	16	F	✓	✓			✓
Rivenstone™	16	F	✓				
Senzo™	17	SM	✓	✓	✓		✓
Series™	17	WS	✓	✓	✓		✓
Skyline	18	S	✓				
Stonehenge®	18	DW	✓	✓			✓
Thornbury™	19	F	✓	✓	✓		
Town Hall®	19	T	✓	✓	✓	✓	✓
Treo™ Premier	20	F	✓	✓			✓
Tribeca Cobble	20	C	✓	✓			✓
Turfstone™	22	S		✓		✓	
Umbriano®	21	SZ	✓	✓	✓		✓
Unigranite®	22	SP	✓	✓			✓

RETAINING WALLS

Product	Page	Finish	Gardens	Retaining Walls	Steps	Seatwalls	Pillars
Brussels Dimensional System™	23	W	✓	✓	✓	✓	✓
DuraHold®	24	S		✓			
DuraHold2®	25	S		✓			
Estate Wall®	26	SP/W	✓	✓	✓	✓	✓
Lineo™ Dimensional Stone	27	SZ	✓	✓	✓	✓	✓
Pisa2®	28	SP	✓	✓	✓	✓	✓
Rivercrest® Wall	29	F	✓		✓	✓	✓
RomanPisa®	30	SP/W	✓	✓	✓	✓	✓
RomanStack®	30	SP/W	✓				
SienaStone®	31	SP		✓	✓		
Split'n Stack®	32	SP	✓				
U-Cara™	33	Various	✓	✓	✓	✓	✓

**FINISHES:** B=Brushed; C=Cobblestone; D=Dimpled; DW=Dimpled and Weathered; F=Flagstone; S=Standard; SM=Smooth; SZ=Smooth Zero Bevel; SP=Split; SP/W= Split and Weathered; T=Timeworn; W=Weathered; WS=Washed  
 This application chart should only be used as a guide. Site conditions, base materials, pattern, and frequency of use may vary the performance of various types and styles of products.





DESIGNED TO CONNECT.™

BOSTON  
(508) 278-4536

**CLEVELAND**  
(330) 927-4000

NEW YORK  
(845) 278-6700

BUFFALO  
(716) 822-6074

DETROIT  
(248) 437-7037

ONTARIO  
(416) 646-9000

CHICAGO  
(630) 892-9191

MILWAUKEE  
(262) 742-3890

**UNILOCK.COM | 1-800-UNILOCK**

©2019 Hengestone Holdings, Inc.